

DAILY CLOSET SINGLE 110x50CM

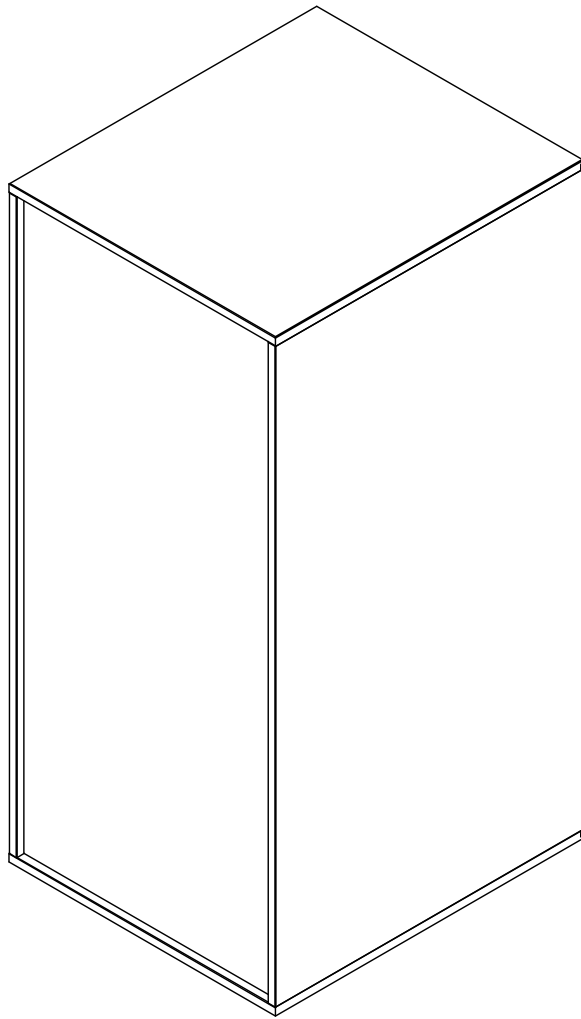

vtwonen

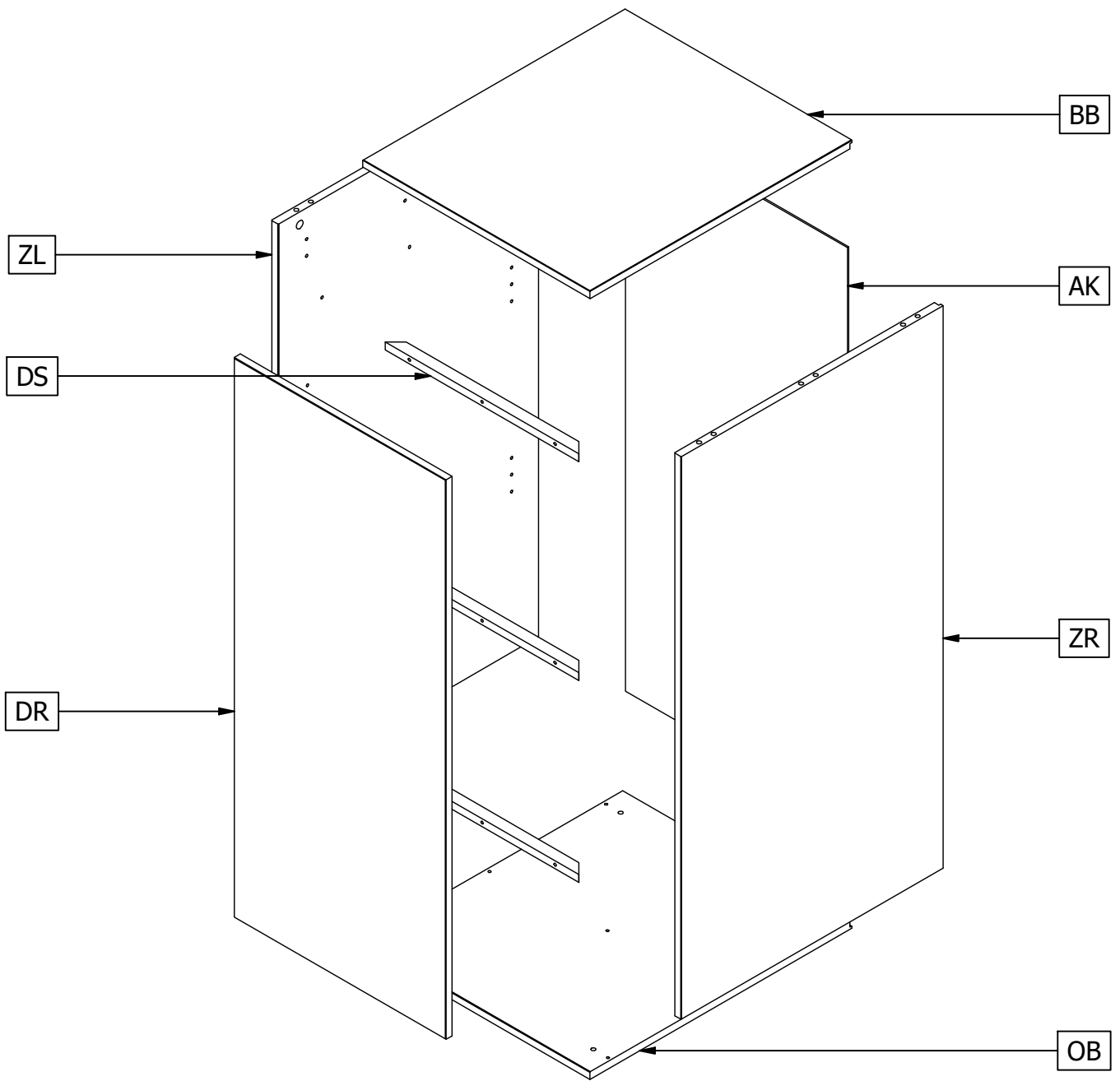

Qty	Code	Thickness	Length	Width
1	AK	3	1087	487
1	BB	15	499	575
1	DR	15	1064	465
3	DS	15	425	24
1	OB	15	499	575
1	ZL	15	1070	575
1	ZR	15	1070	575

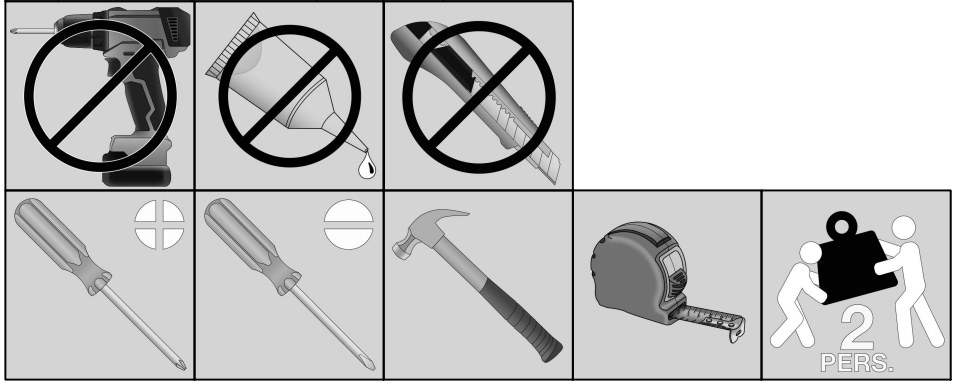



Nederlands

WAARSCHUWING.

Voorkom dat dit meubel omvalt. Meubels die omvallen kunnen ernstig of levensbedreigend letsel veroorzaken. Het meegeleverde kantelbeslag dient daarom **BESLIST** te worden gebruikt om het meubel te bevestigen aan de muur.

Sta niet toe dat kinderen klimmen op lades, deuren of planken.
Plaats zware voorwerpen altijd onderin.
Zet zware voorwerpen nooit op het meubel.

Norsk

ADVARSEL.

Unngå at dette møbelet faller. Møbler som faller kan forårsake alvorlige eller livstruende skader. Det medleverte beslaget skal derfor **ABSOLUTT** brukes for å feste møbelet til veggen.

Ikke tillat at barn klatrer på skuffer, dører eller planker.
Plasser tunge objekter alltid nederst.
Sett aldri tunge objekter på møbelet.

Deutsch

WARNHINWEIS.

Verhindern Sie, dass dieses Möbelstück umstürzt. Möbel, die umfallen, können schwere oder lebensbedrohliche Verletzungen verursachen. Zur Befestigung des Möbelstücks an der Wand sollte daher **UNBEDINGT** die mitgelieferte Kippsicherung verwendet werden.

Erlauben Sie Kindern nicht, auf Schubladen, Türen oder Regale zu klettern.
Stellen Sie schwere Gegenstände nur unten in das Möbelstück.
Stellen Sie niemals schwere Gegenstände auf das Möbelstück.

Français

ATTENTION.

Évitez que le meuble ne bascule. Les meubles qui basculent peuvent être à l'origine de blessures graves ou mortelles. La fixation anti-basculement fournie avec le meuble doit **OBLIGATOIREMENT** être utilisée pour fixer celui-ci au mur.

Ne laissez pas les enfants grimper sur les tiroirs, portes ou étagères.
Placez toujours les objets lourds dans le bas du meuble.
Ne placez jamais les objets lourds sur le meuble.

English

CAUTION.

Prevent this furniture from falling over. Falling furniture could cause severe or life-threatening injuries. Therefore, the included tip-over restraint **HAS** to be used to secure the furniture to the wall.

Do not allow children to climb on the drawers, doors or shelves.
Always place heavy objects at the bottom.
Never place heavy objects on top of the furniture.

Svenska

VARNING.

Förhindra att denna möbel välter. Möbler som välter kan orsaka allvarliga eller livshotande skador. Det medföljande tippskyddet **MÅSTE** därför användas för att förankra möbelen i väggen.

Låt inte barn klättra på lådor, dörrar eller hyllor.
Placera alltid tunga föremål längst ned.
Ställ aldrig tunga föremål på möbelen.

Polski

UWAGA.

Zabezpiecz meble przed przewróceniem. Przewrócenie się mebli może spowodować poważne lub śmiertelne obrażenia ciała. Dlatego załączone ograniczniki przechyli **ZDECYDOWANIE** powinny zostać wykorzystane do przymocowania mebla do ściany.











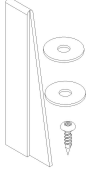
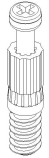

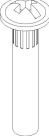
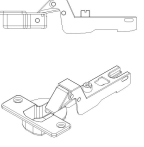

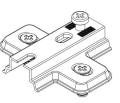
Nie pozwalaj dzieciom wspinać się na szuflady, drzwiczki lub półki.
Zawsze umieszczaj ciężkie przedmioty w dolnej części.
Nigdy nie stawiaj na meblu ciężkich przedmiotów.

Español

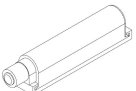
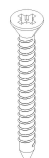
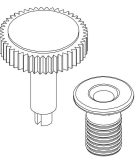
ADVERTENCIA.

Evite que este mueble se caiga. Los muebles que se caen pueden ocasionar lesiones graves o potencialmente mortales. Por lo tanto, el herraje abatible suministrado debe utilizarse **SIN LUGAR A DUDAS** para fijar el mueble a la pared.

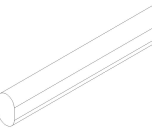
No permita que los niños se suban a los cajones, las puertas o los estantes.
Los objetos pesados siempre deben colocarse en la parte inferior.
Nunca coloque objetos pesados sobre el mueble.

6	Ø15mm	AC000102 	1	Safety Strip	AC000356 
6	24mm	AC000103 	10	Ø14mm	AC000369-* 
5	M4X27 Ø5	AC000154 	2	Ø35 15V	AC000413 
5	M4x15mm	AC000155 	2	0mm	AC000426 
2	3x15mm	AC000201 	6	8x35mm	AC000601 
6	4x16mm	AC000204 	1	Push To Open	AC003017 
9	3.5x35mm	AC000219 	4	M6x16	AC007549 
6	5x40mm	AC000238 	1	Screwdriver	AC007550 
25	Ø1.4x25mm	AC000316 	1	L=462	AC000902 
2	Ø5mm	AC000335 			

1

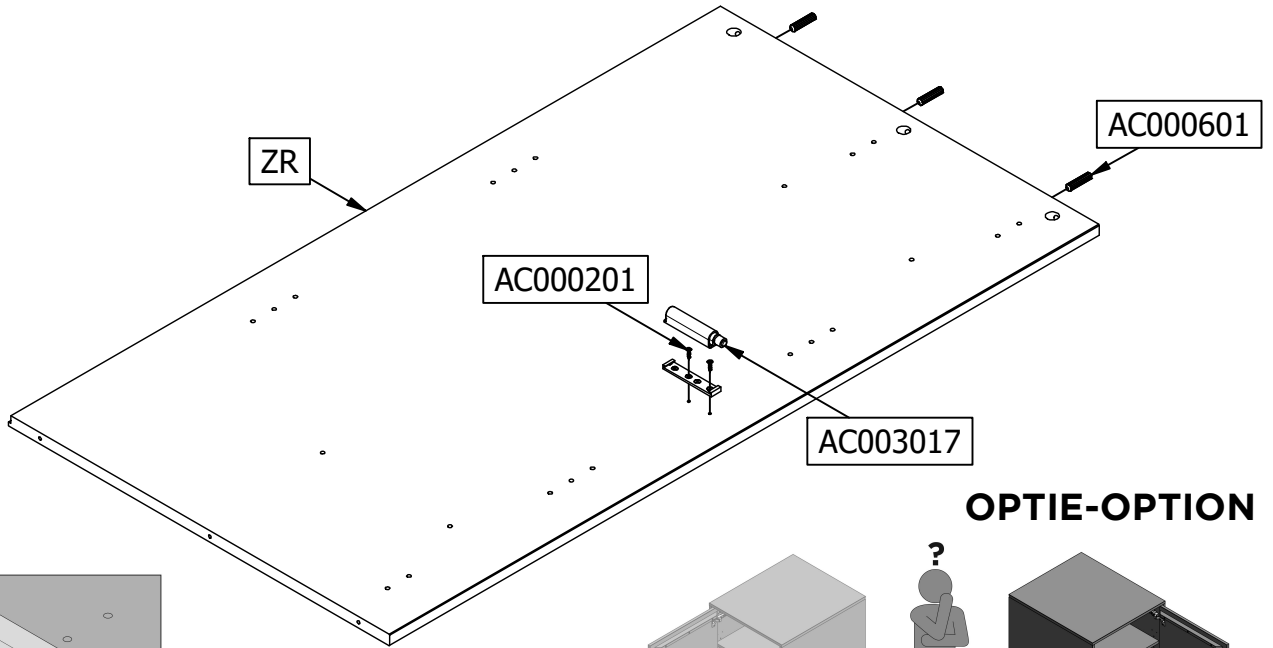
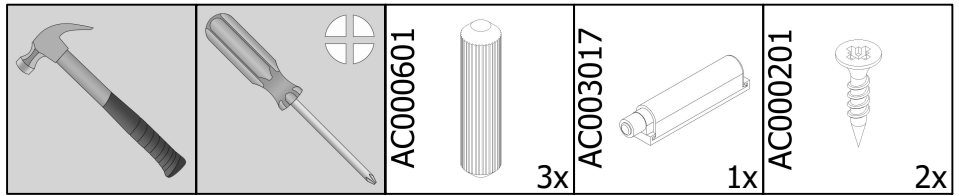

OPTIE-OPTION

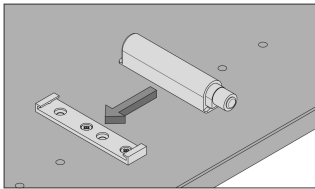
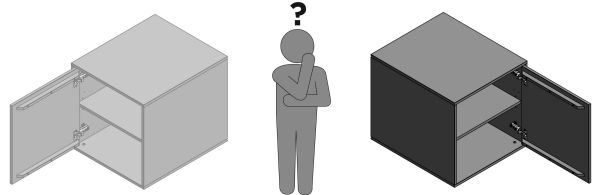

2

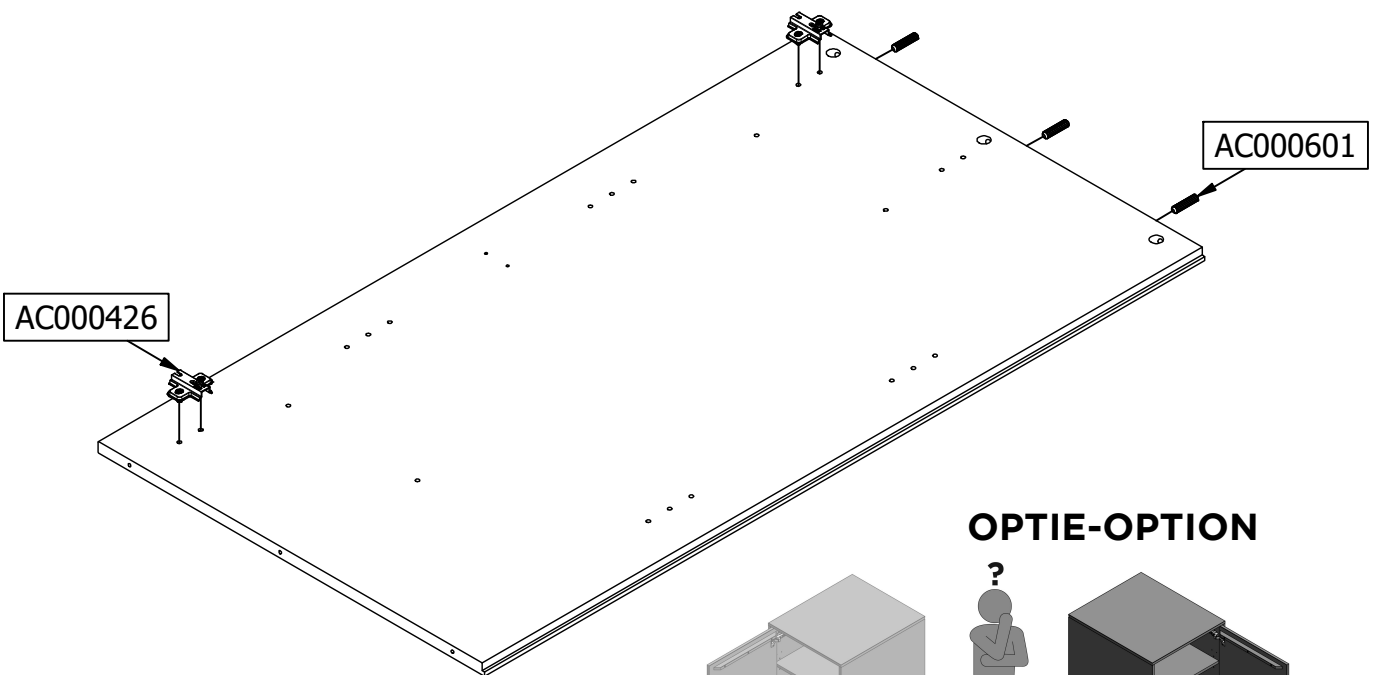
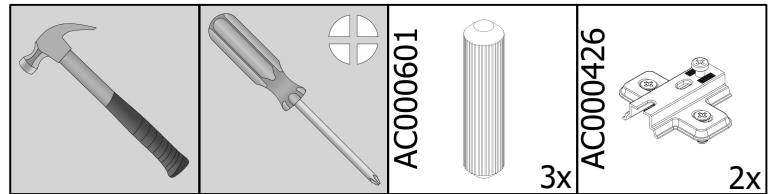

OPTIE-OPTION

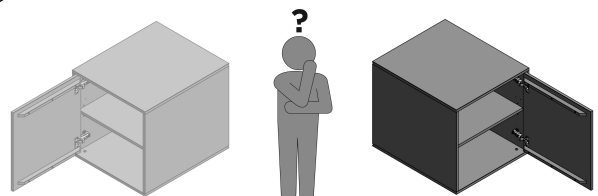

1

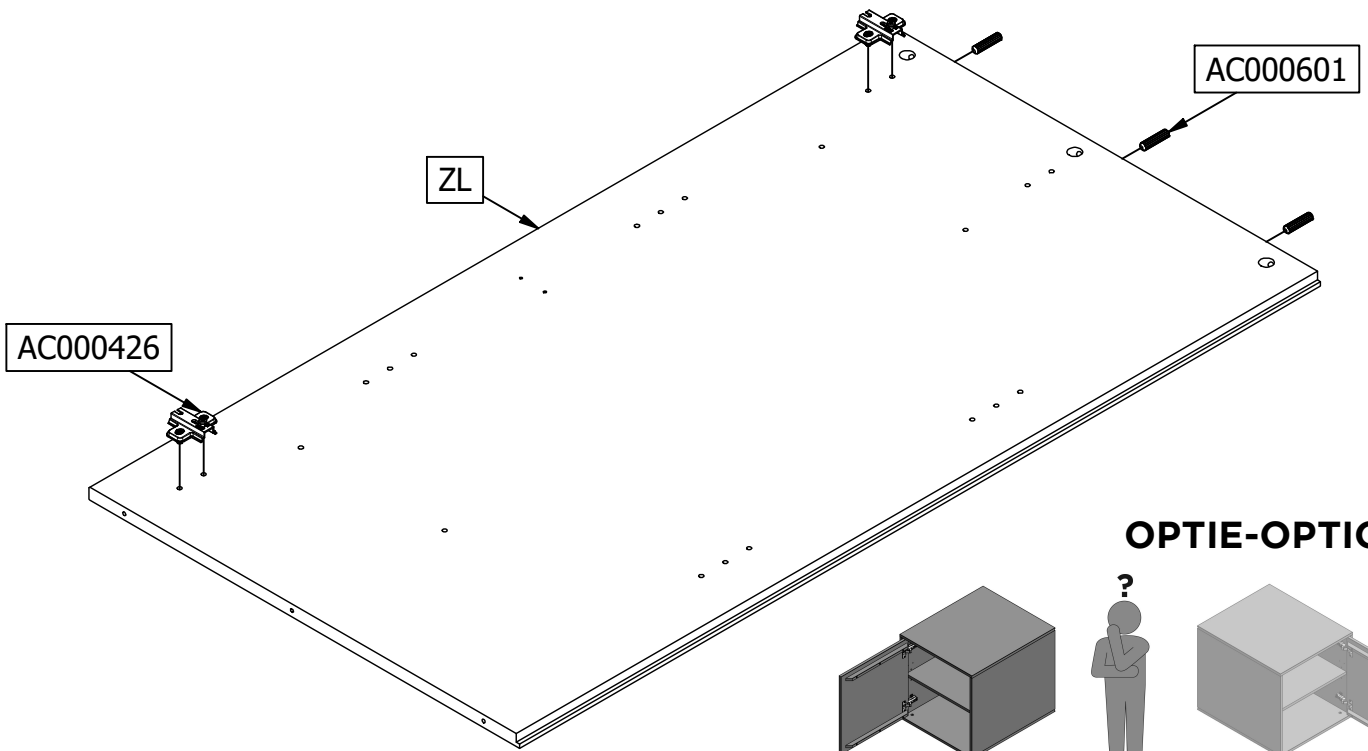
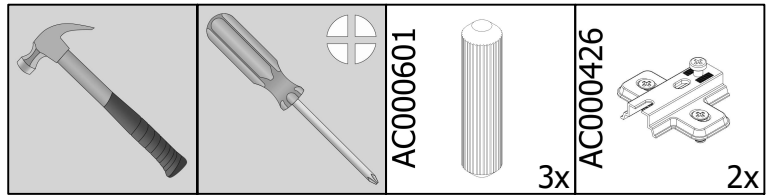

2

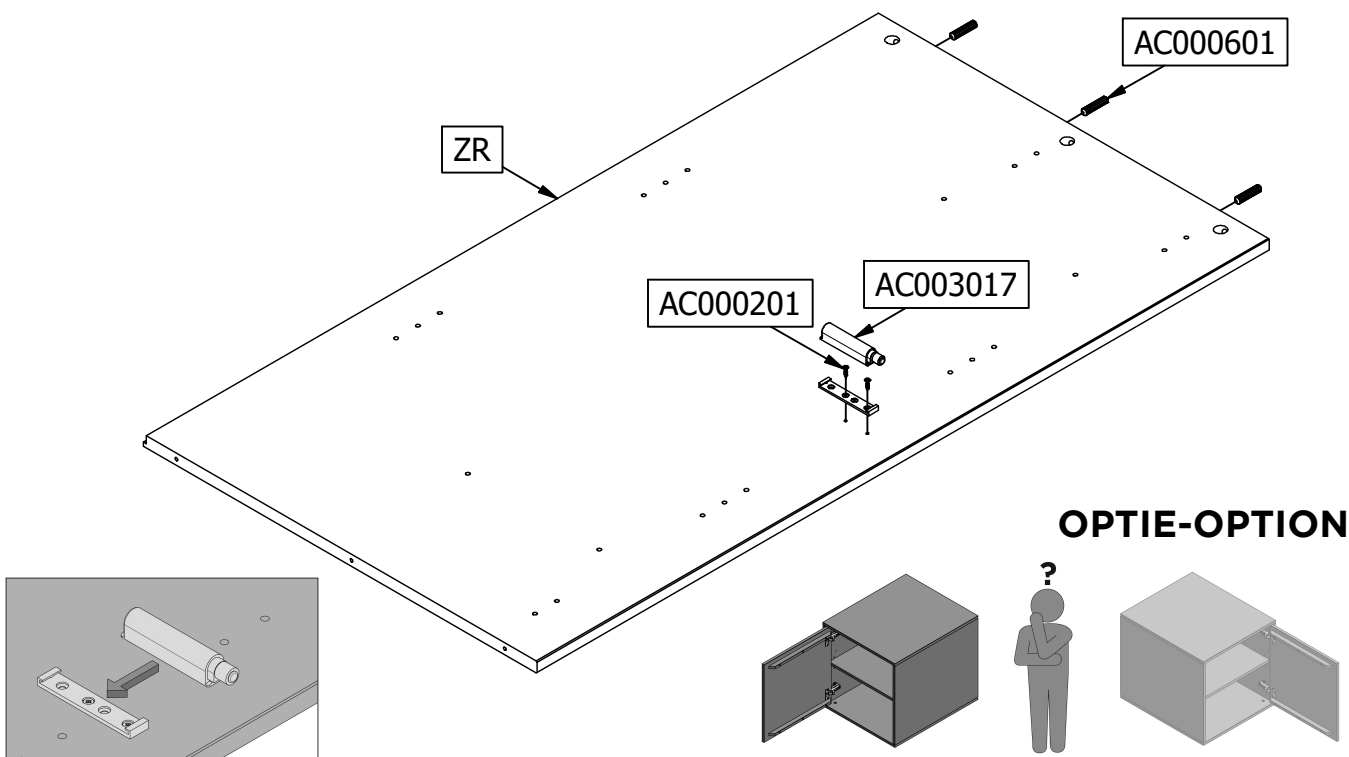
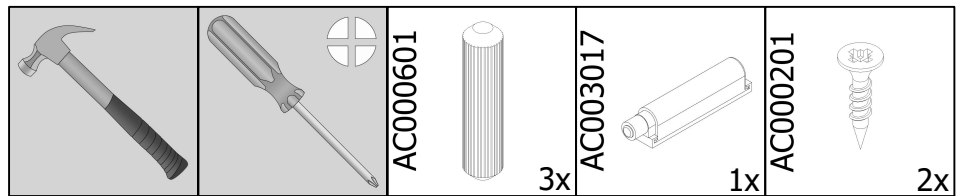

3

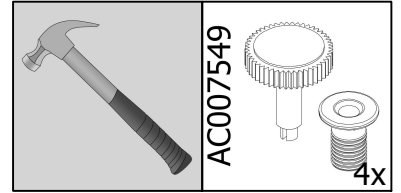
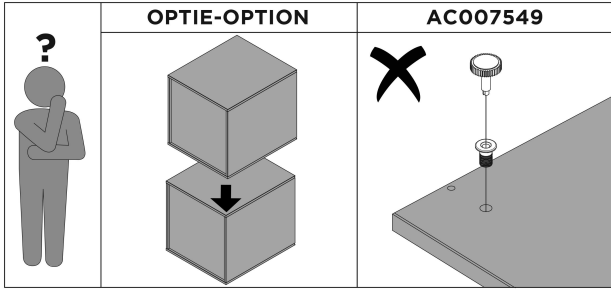

AC007549

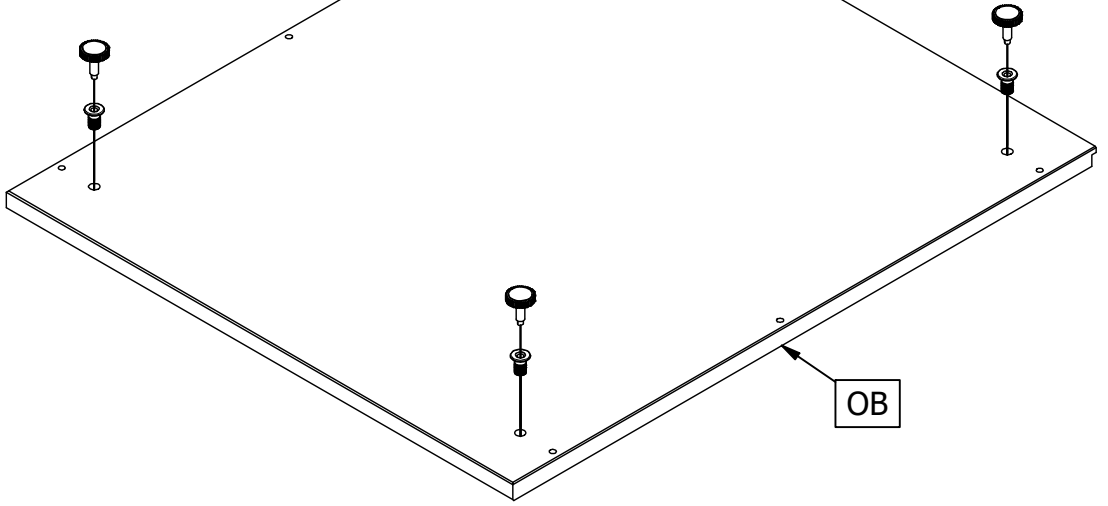
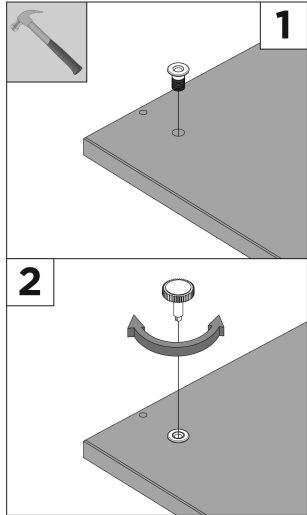

OB

4

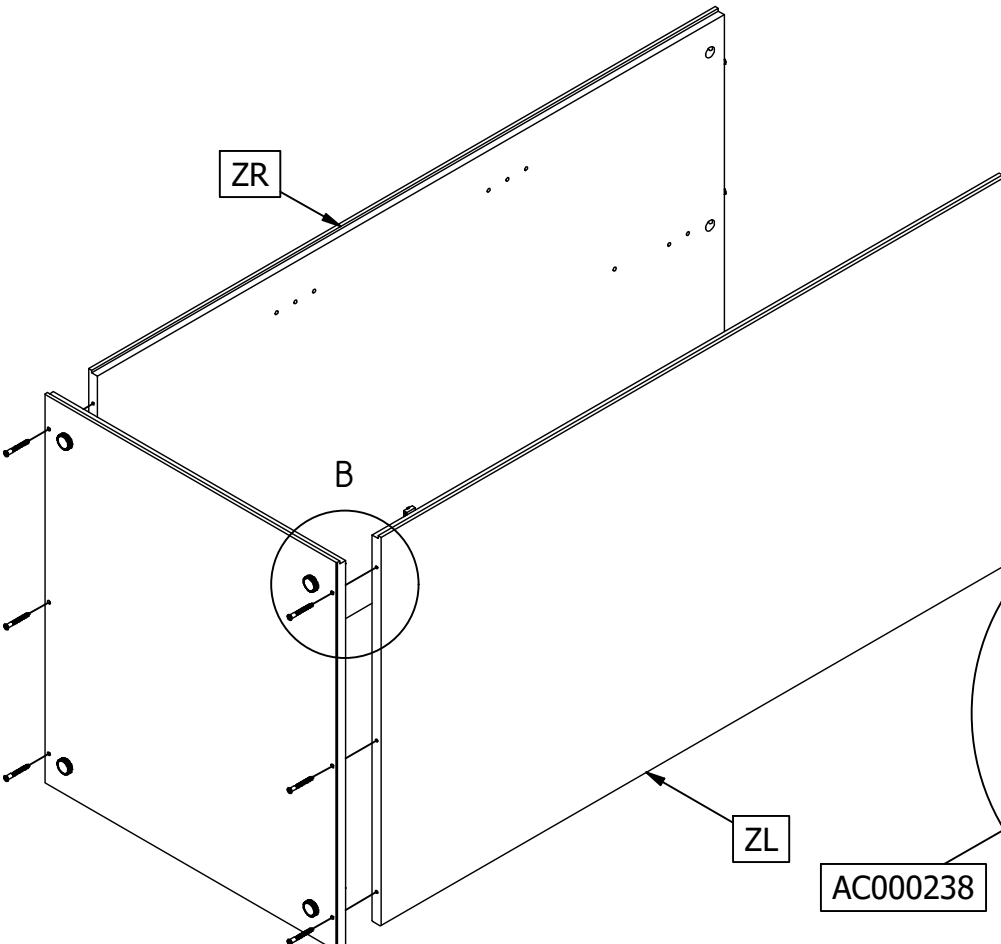
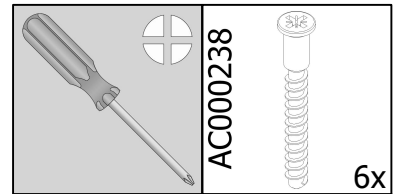

ZR

B

ZL

AC000238

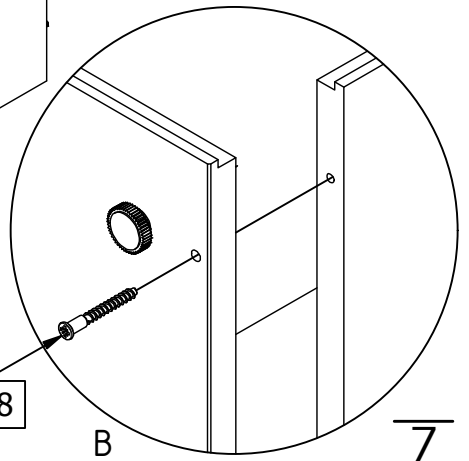

B

7

5

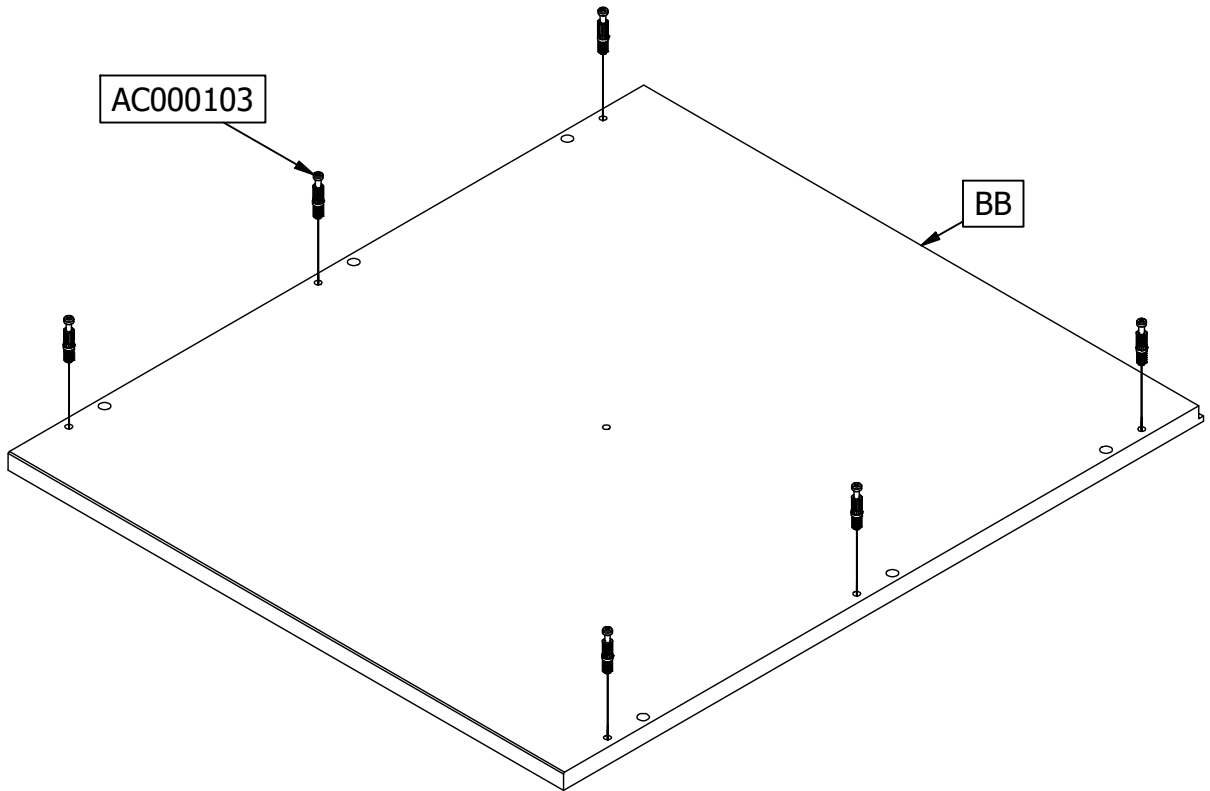
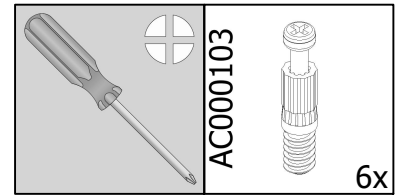
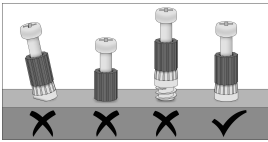

6

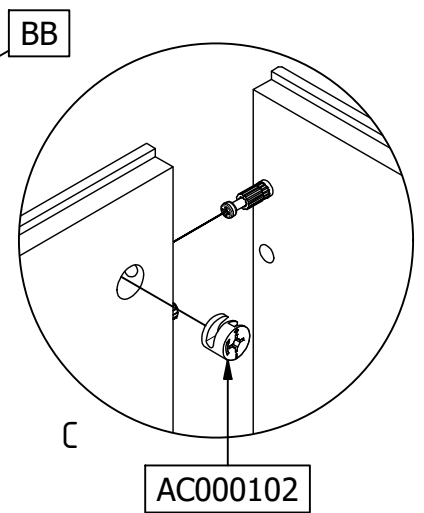
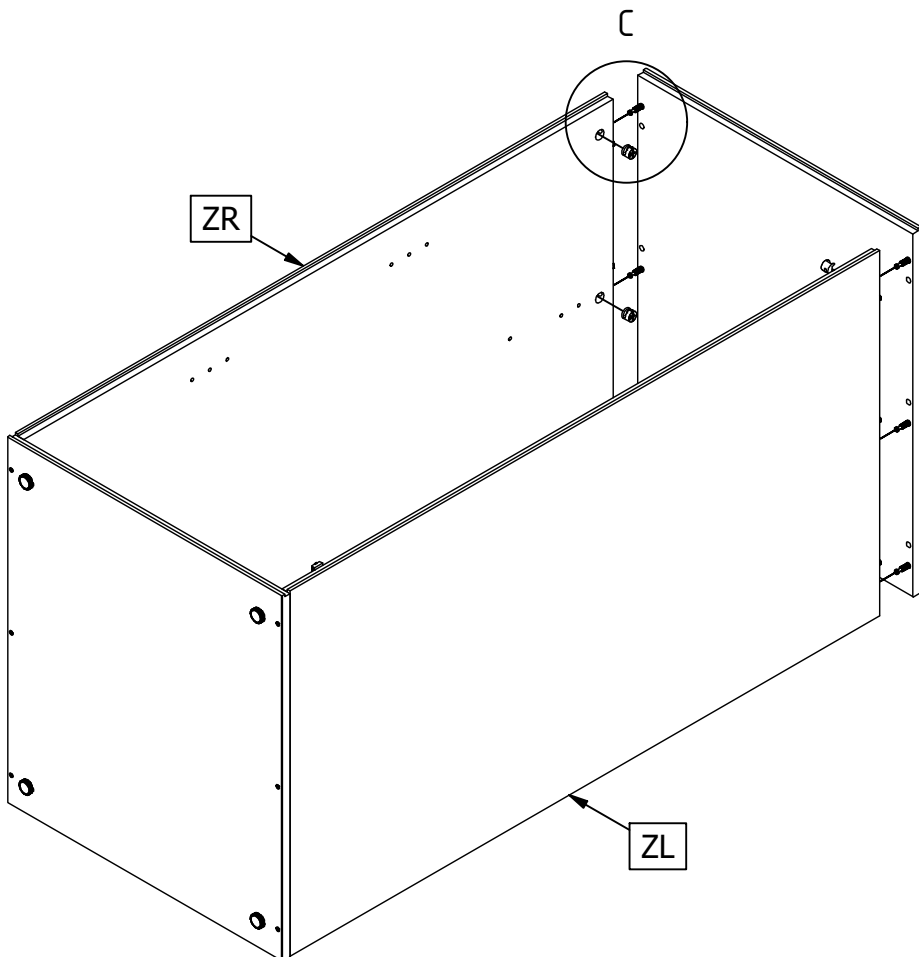
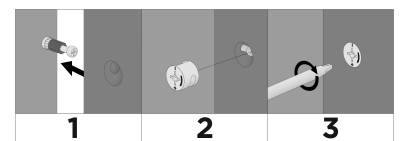
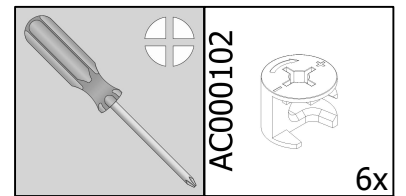

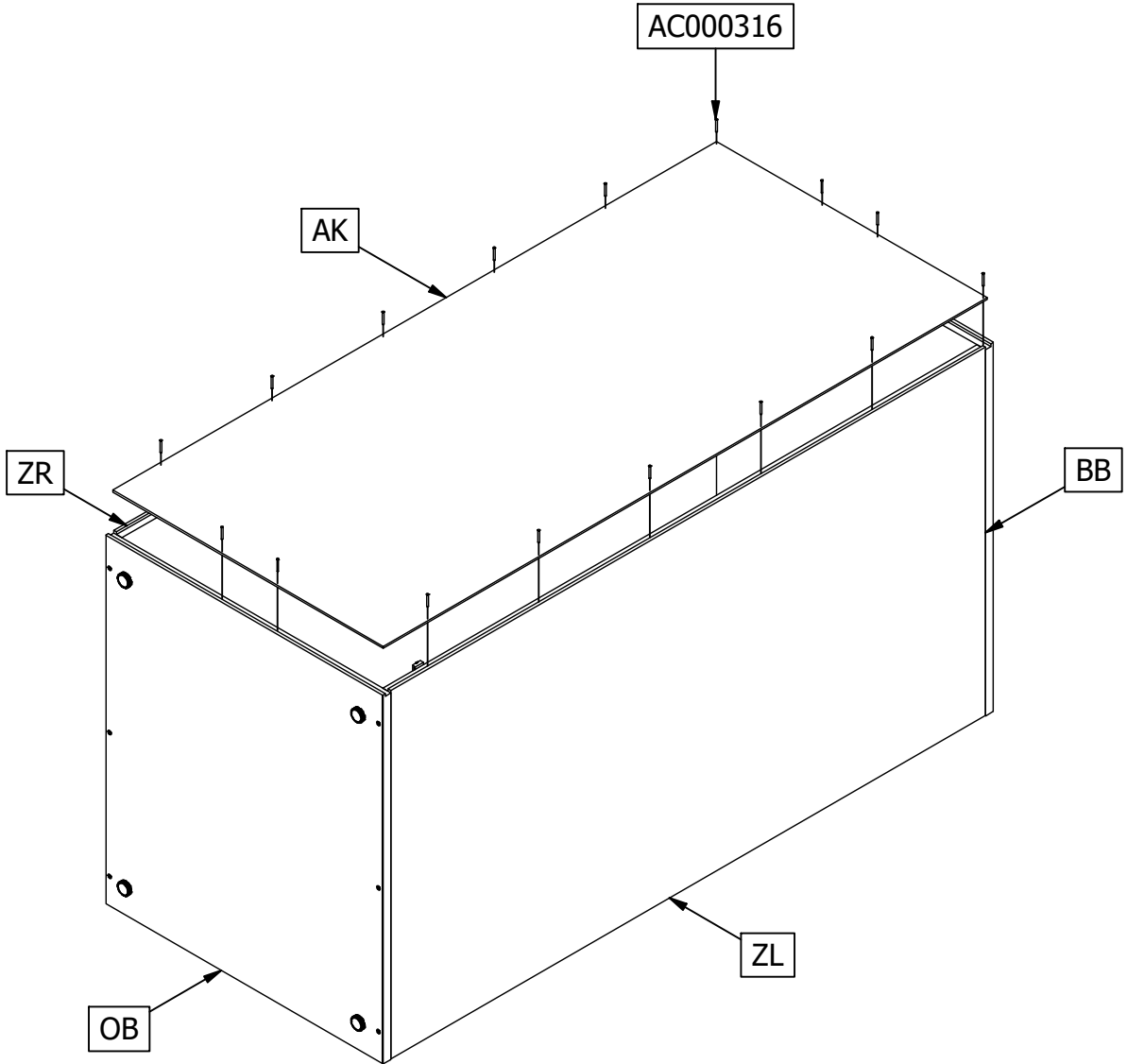
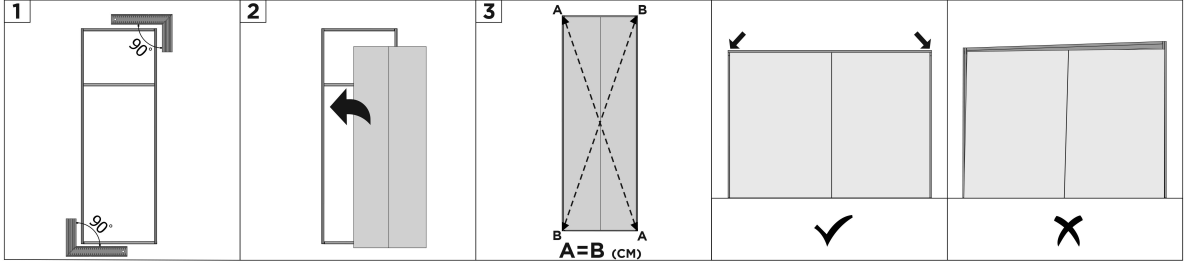
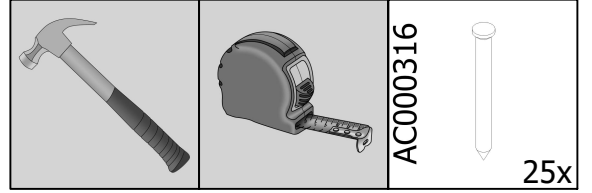

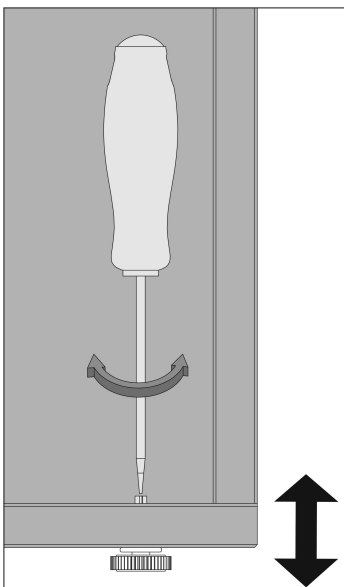
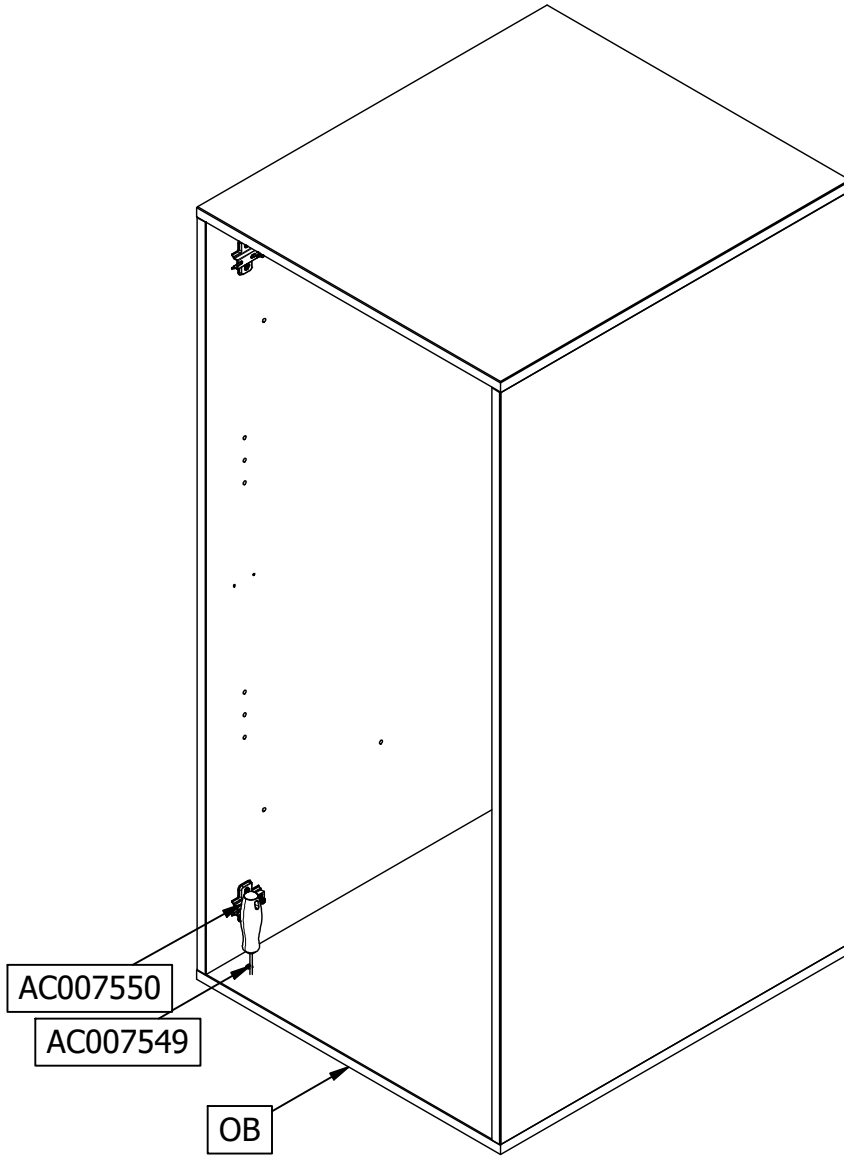
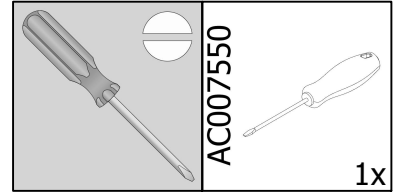

1



OPTIE-OPTION

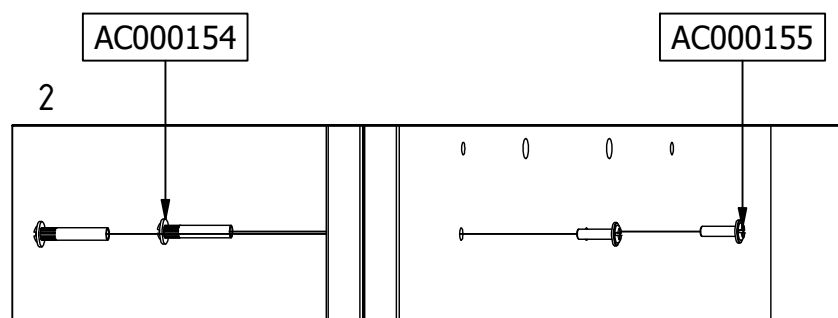
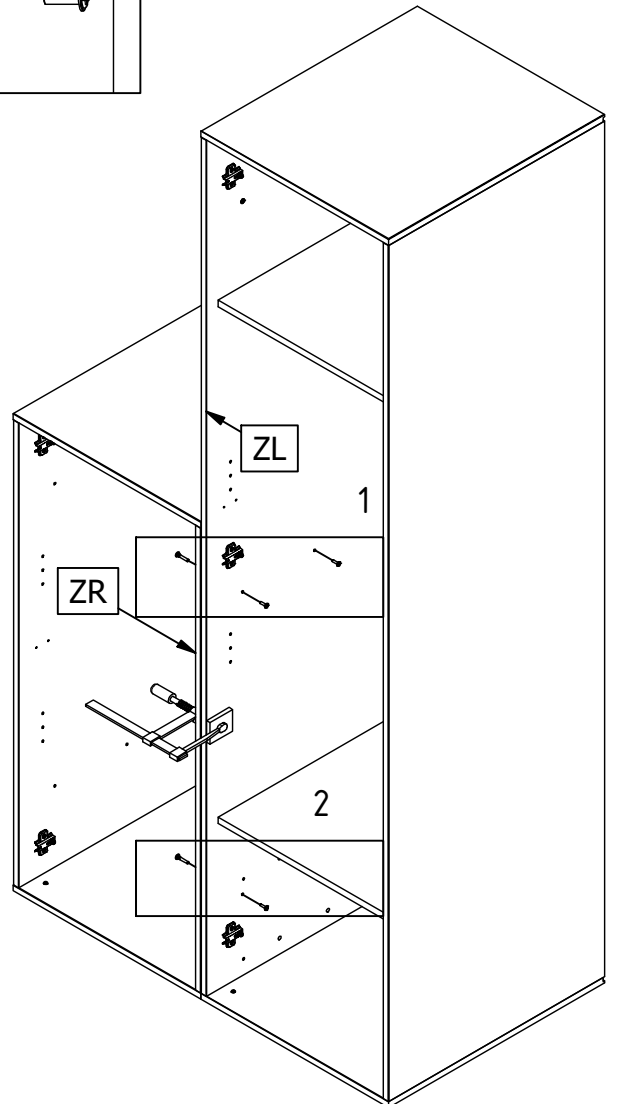
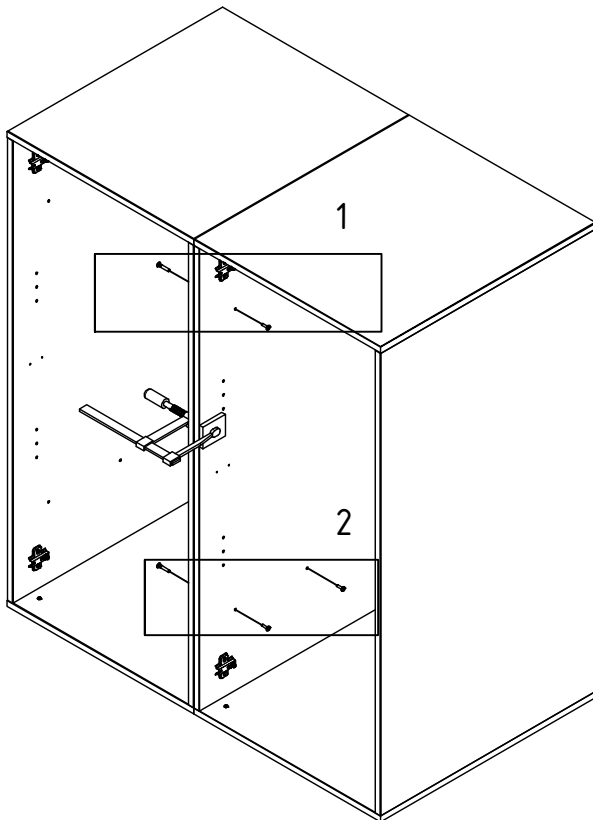
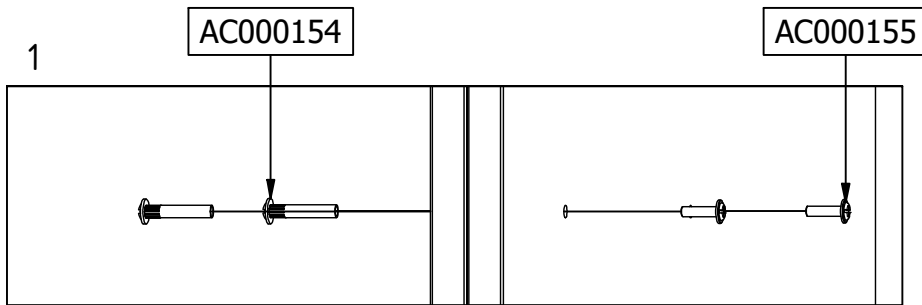

OPTIE-OPTION

400497-M

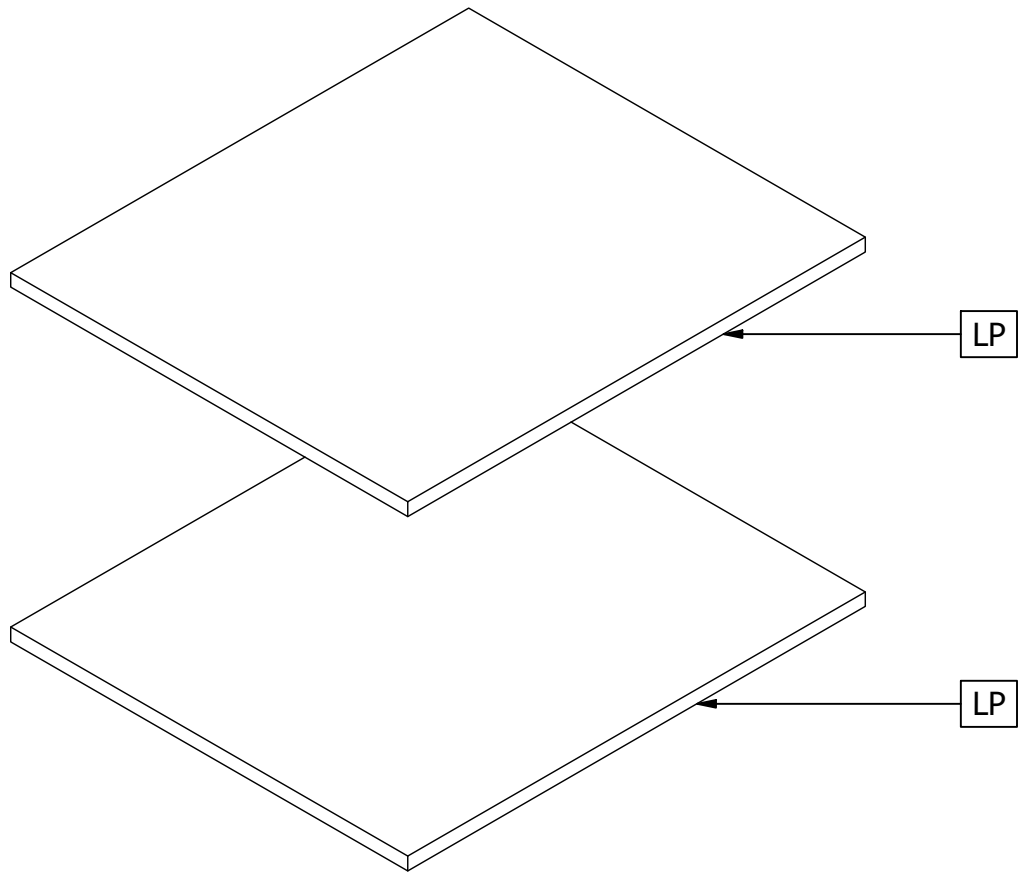

SHELVES - REGALS - ÉTAGÈRE

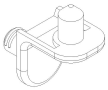

Qty	Code	Thickness	Length	Width
2	LP	15	468	540
8	Ø5mm		AC000349	

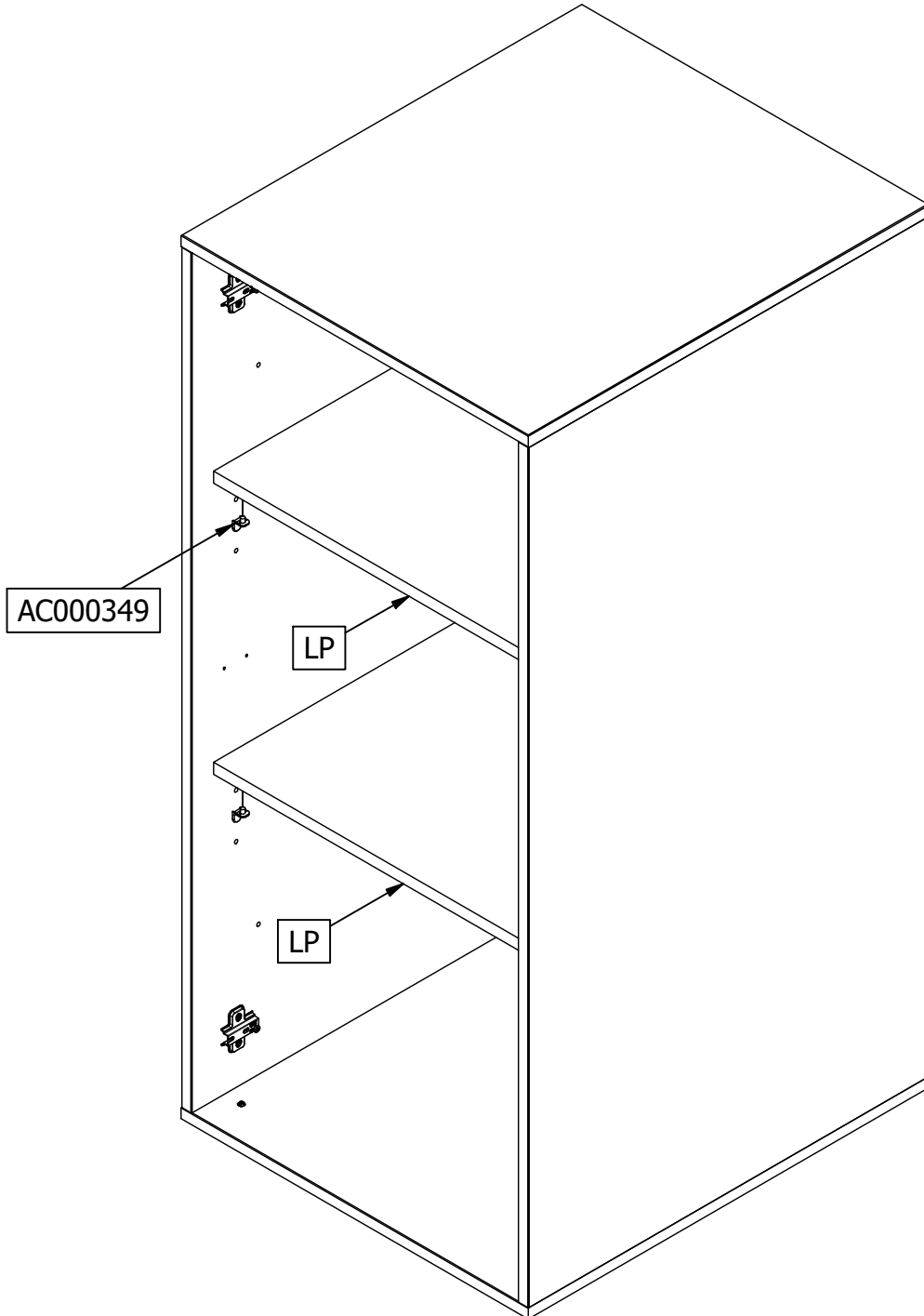
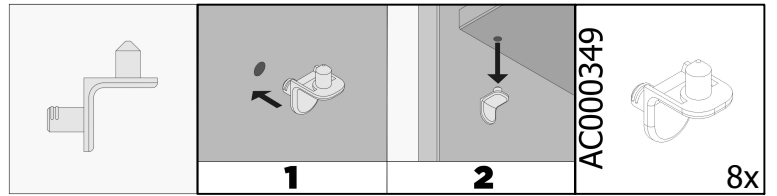
1 OPTIE-OPTION

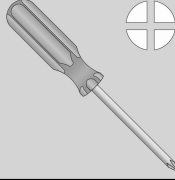
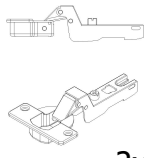
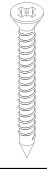

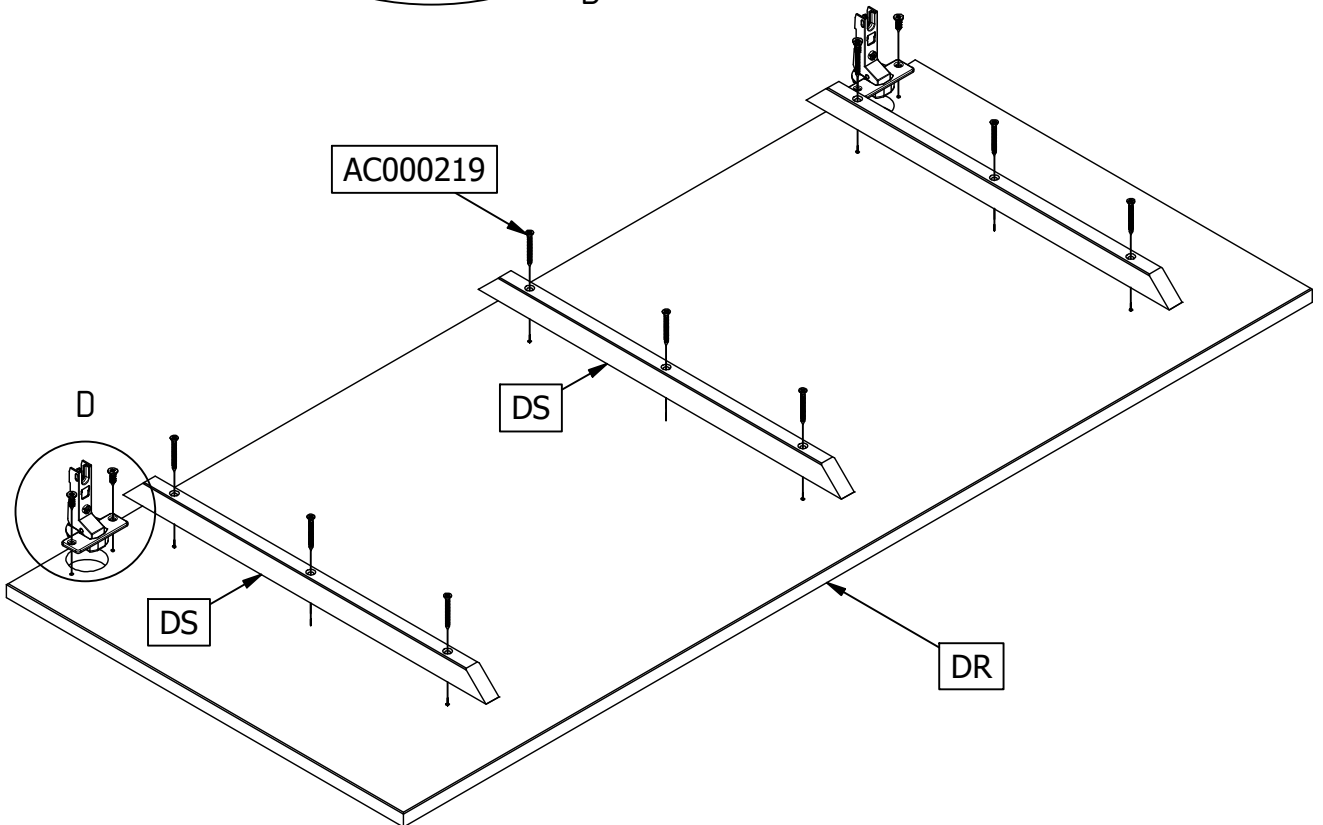
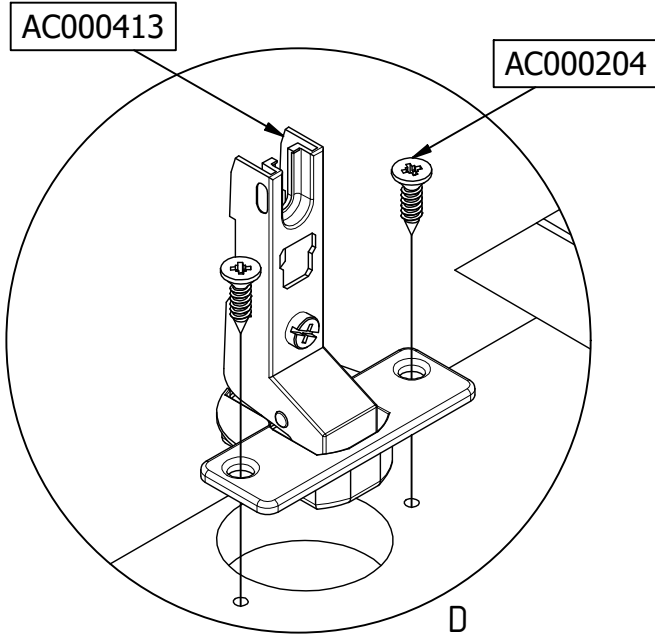

	 AC000413 2x	 AC000219 9x	 AC000204 4x
---	--	---	---

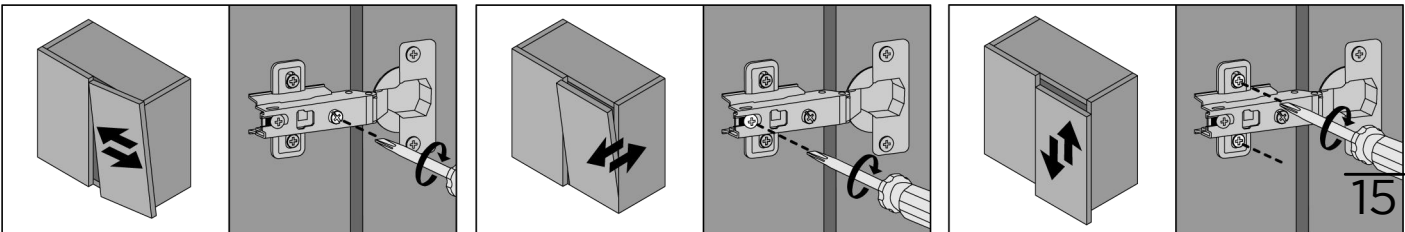
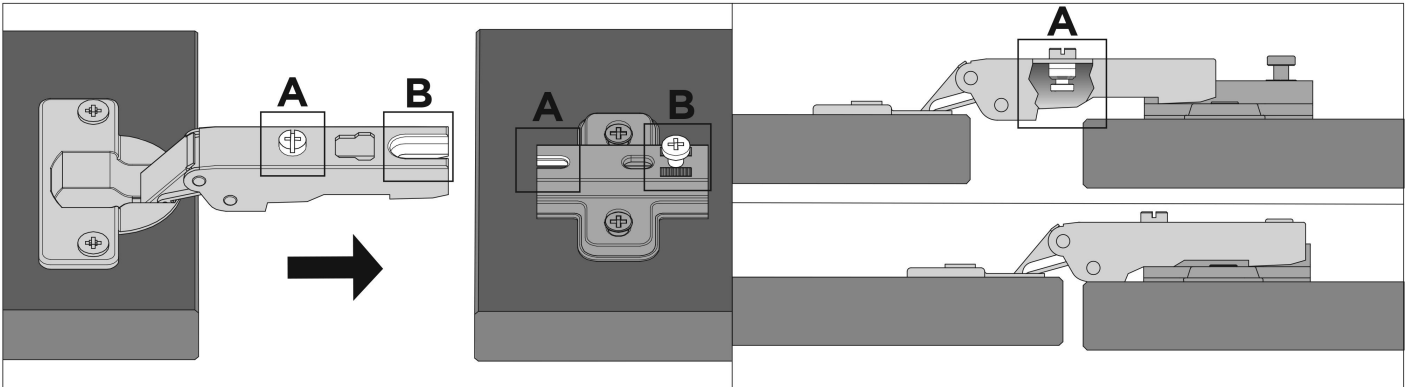
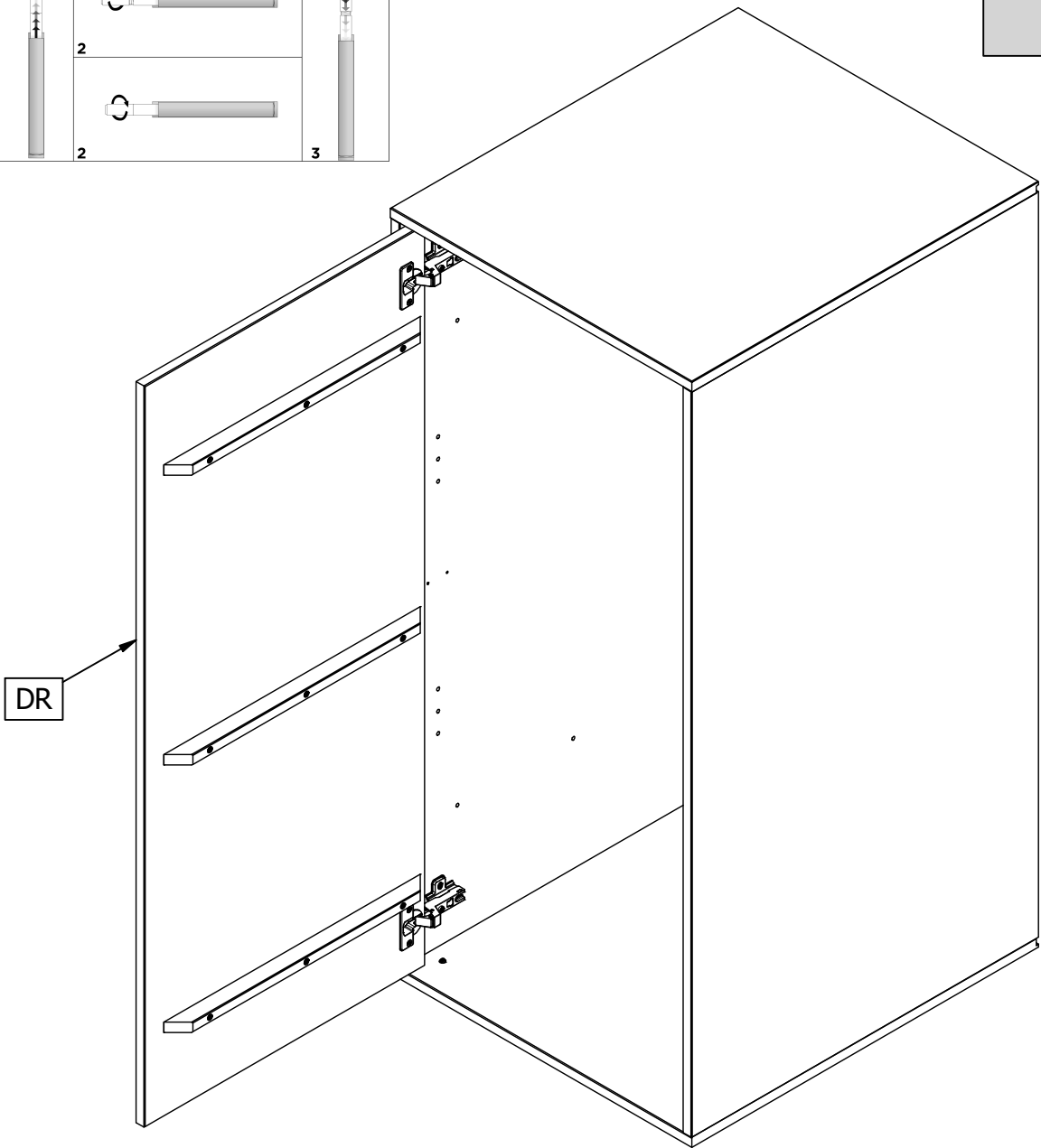
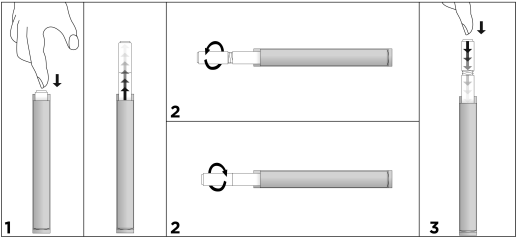
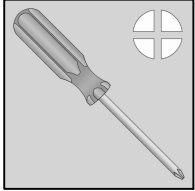

10

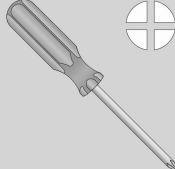
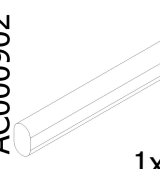

	AC000902		AC000335		AC000204	
		1x		2x		2x

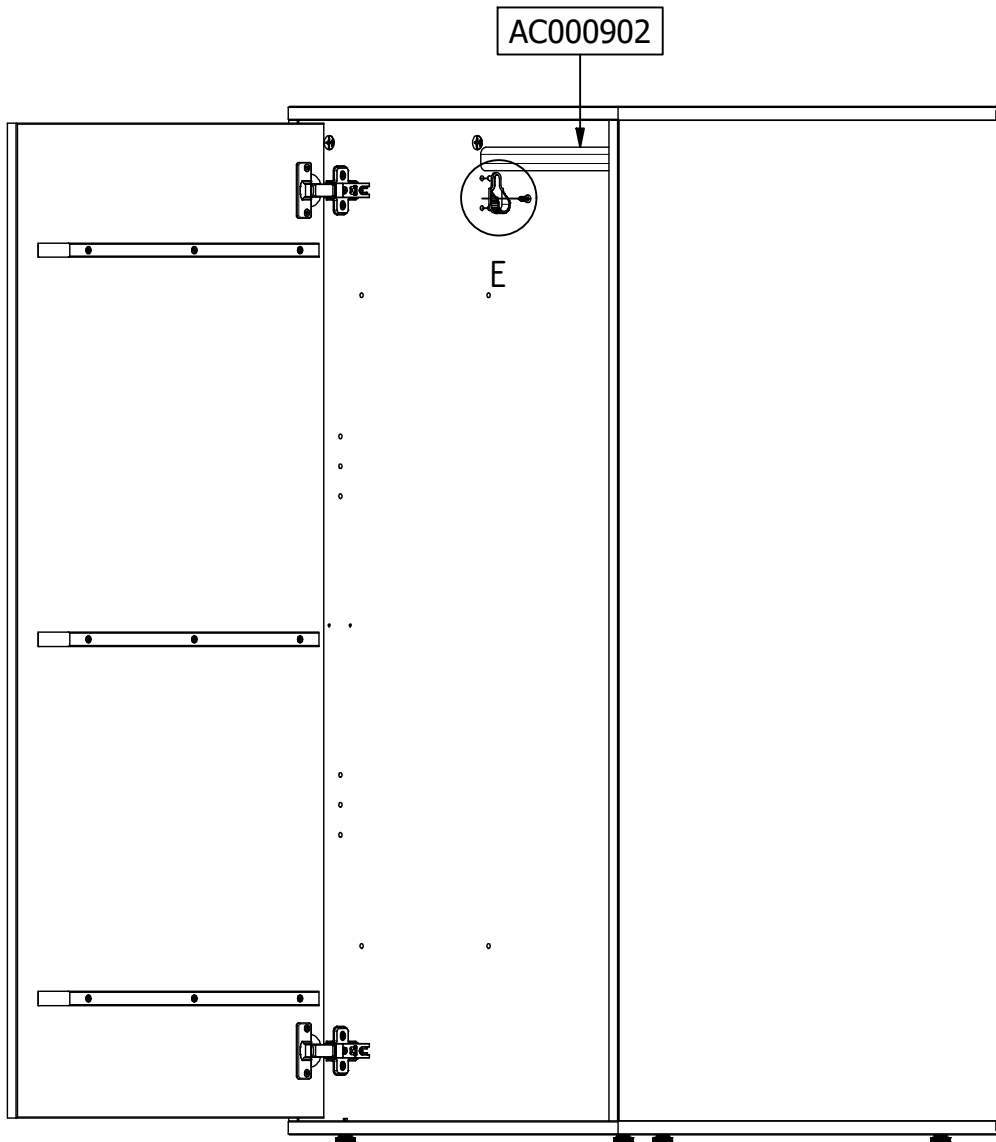
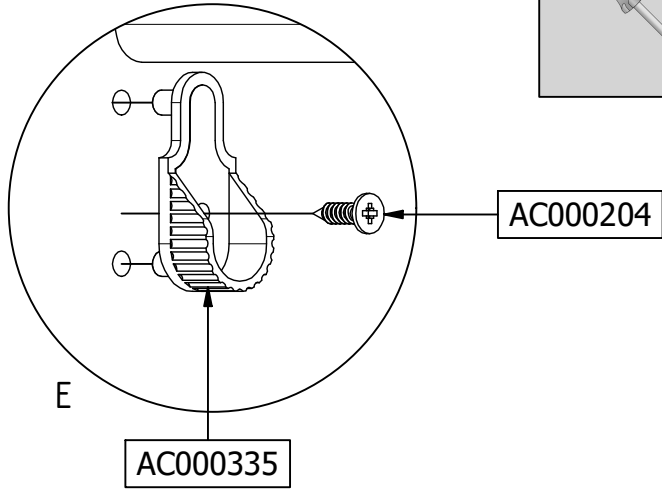

12

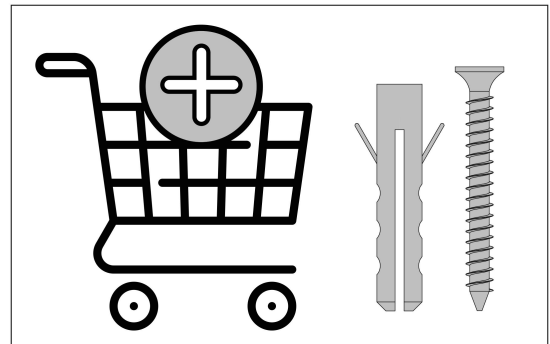
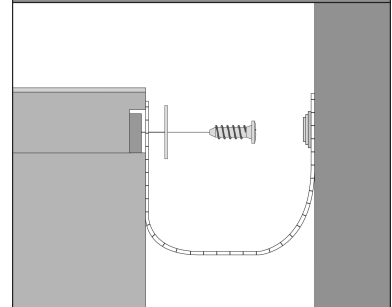
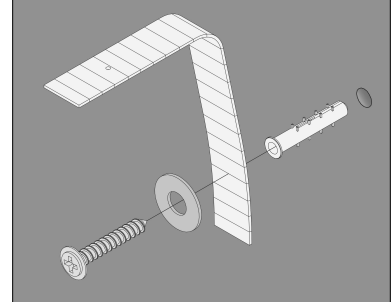
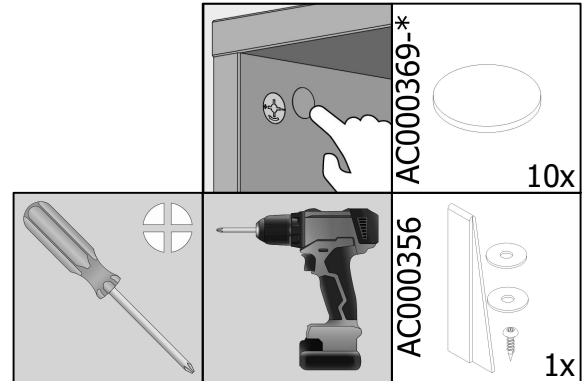
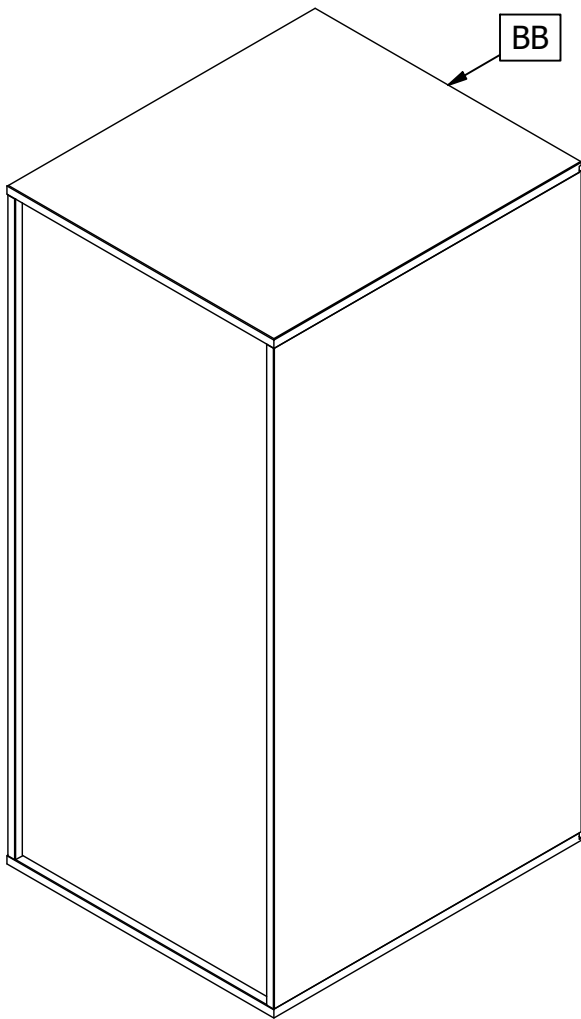
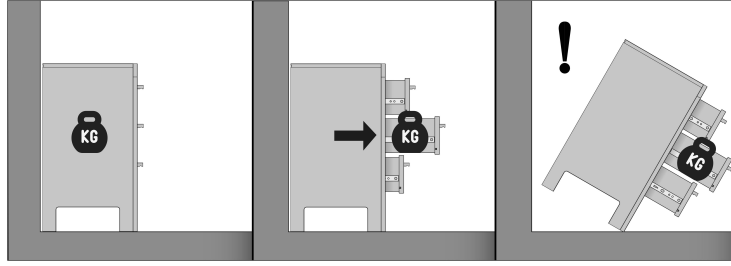

SHARE HAPPINESS

Blij met je nieuwe vtwonen aanwinst? Style het thuis op jouw manier, maak een foto en deel op social media met **#vtwonenbijmijthuis**

We are curious about the result! Would you like to share it with us? Use **#vtwonenbijmijthuis** on social media.
Wir sind gespannt auf das Ergebnis! Möchten Sie mit uns teilen? Benutzen Sie **#vtwonenbijmijthuis** in Social Media.
Nous sommes impatient de connaître le résultat. Souhaitez-vous le partager avec nous?
Utilisez **#vtwonenbijmijthuis** sur les médias sociaux.



facebook.com/vtwonen



instagram.com/vtwonen



pinterest.com/vtwonen

Bewaar deze handleiding • Please save this manual • Bitte bewahren Sie diese Montageanleitung • Merci de garder la notice de montage

De Eekhoorn Dutch Furniture | Jan Tinbergenweg 1 | 1689 ZV Hoorn | The Netherlands