

# Product Manual

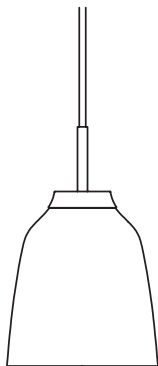

## Campa Pendant Designed by Spant Studio

Version 002 - 05/2023

**Bolia.com**

Vaerkmestergade 11-13  
8000 Aarhus C, Denmark  
+45 51 50 51 22

## EN

Read the product manual carefully before using your product. If you do not follow the instructions, there is a risk that you could damage the product or in the worst case cause injury. Keep the product manual for future reference. If the product is later passed on to third parties, this manual must also be provided.



This symbol indicates a warning regarding the care, handling, or use of the product. If such a warning is not followed, there is a risk that you could damage the product, or in the worst case cause injury.

Use the product only for the purpose described in this manual. Any other use does not correspond to the intended purpose of the product and can lead to damage to the product or injuries. The manufacturer or dealer accepts no responsibility for damage resulting from the use of the product in a manner for which it is not intended. Incorrect, improper use of the product can lead to personal injuries. Children must not play with the packaging film, as there is a risk that they will be wrapped up in it and caught. Before using the product, make sure that there is nothing that can harm or injure people.

### Risk of damaging the product

Incorrect, improper use, handling and cleaning can damage parts or the entire product.

Do not step on or jump on the product. It is not intended for this.

Do not use a hard brush, solvent, corrosive or strong cleaning agent to clean the products, if not advised by Bolia.com.

Do not push or pull the luminaire over the floor. This could damage both the luminaire and the floor.

Always lift the luminaire to move it.

Always use recommended care and cleaning products.

Further information can be found on our website: [Bolia.com](http://Bolia.com)

### Technical information

As we are constantly developing and improving our products, design and technical changes may occur. This products manual can be downloaded as a PDF file from our website: [Bolia.com](http://Bolia.com)



### Disposal of packaging & product

Dispose of the product and packaging in accordance with local waste regulations.



Packaging materials must be separated and disposed of properly.

For user instructions in another language,  
please follow this link







**EN: Safety precautions**

The core with green/yellow insulation must only be connected to a terminal marked with  or .

If the external flexible cable or cord of this luminaire is damaged, it shall be exclusively replaced by the manufacturer or his service agent or a similar qualified person in order to avoid a hazard.

**DK: Sikkerhedsforanstaltninger**

Den grønne og gule ledning må kun være forbundet til indgangen markeret med  eller .

Hvis lampens udvendige ledning bliver beskadiget skal der, for at undgå en farlig situation, rettes henvendelse til producenten, service agenten eller anden lignende kvalificeret person for udskiftning af denne.

**DE: Sicherheitsvorkehrungen**

Die grün/gelb isolierte Ader darf nur an eine Klemme angeschlossen werden, die wie folgt gekennzeichnet ist  oder .

Wenn das äußere flexible Kabel oder die Schnur dieser Leuchte beschädigt ist, darf nur der Hersteller oder sein Kundendienst oder eine ähnlich qualifizierte Person das Kabel ersetzen, um eine Gefährdung zu vermeiden.

**FR: Précautions de sécurité**

Le câble vert et jaune doit être connecté uniquement à une borne marquée par  ou .

Si le câble flexible externe ou le cordon de ce luminaire est endommagé, il doit être exclusivement remplacé par le fabricant, son agent de service ou une personne qualifiée similaire afin d'éviter tout danger.

**ES: Medidas de seguridad**

El cable verde/amarillo solo debe conectarse a un terminal marcado con  o .

Si el cable externo o cordón de esta luminaria es dañado, deberá ser reemplazado exclusivamente por el fabricante, su agente comercial o persona cualificada similar para evitar cualquier peligro.



**EN: IMPORTANT!**

Always switch off power before installation. In some countries electric installations may only be performed by a licensed electrician. Follow directions by relevant authorities.

**DK: VIGTIGT!** Sluk altid for strømmen før installation. I nogle lande må elektriske installationer kun udføres af en autoriseret elektriker. Følg de relevante myndigheders Anvisninger

**DE: WICHTIGER HINWEIS!**

Schalten Sie vor der Installation immer die Stromversorgung aus. In einigen Ländern dürfen elektrische Installationen nur von einem lizenzierten Elektriker durchgeführt werden. Befolgen Sie die Anweisungen der zuständigen Behörden.

**NO: VIKTIG!**

Slå alltid av strømmen før installasjon. I noen land kan elektriske installasjoner kun utføres av en autorisert elektriker. Følg anvisninger fra relevante myndigheter.

**SE: VIKTIGT!**

Bryt alltid strømmen före installation. I vissa länder får elinstallationer endast utföras av behörig elektriker. Följ gällande nationell lagstiftning och regler på området.

**NL: BELANGRIJK!**

Schakel altijd de stroom uit voordat u de installatie uitvoert. In sommige landen mogen elektrische installaties alleen worden uitgevoerd door een erkend elektricien. Volg de aanwijzingen van de bevoegde autoriteiten op.

**FR: IMPORTANT !**

Coupez toujours l'alimentation avant l'installation. Dans certains pays, les installations électriques ne peuvent être effectuées que par un électricien agréé. Suivez les instructions des autorités compétentes.

**ES: ¡IMPORTANTE!**

Desconecta siempre el suministro eléctrico antes de la instalación. En algunos países, las instalaciones eléctricas solo las pueden realizar electricistas autorizados. Sigue las instrucciones proporcionadas por las autoridades competentes.

## Warnings

---



**EN:** IMPORTANT! Mounting screws are not included. Always make sure that the fastening method you choose is suitable and safe for your home. As wall and sealing materials vary, raw plug and screws for fixing to the wall and sealing are not included. Contact your local hardware store for advice on suitable wall plugs and screws.

**DK:** VIGTIGT! Monteringsskruer medfølger ikke. Sørg altid for, at den fastgørelsesmetode, du vælger, er egnet og sikker til dit hjem. Da væg- og loftmaterialer varierer, medfølger der ikke rawplugs og skruer til fastgørelse på væg og loft. Kontakt din lokale isenkræmmer for rådgivning om passende rawplugs og skruer.

**DE:** WICHTIGER HINWEIS! Befestigungsschrauben sind nicht enthalten. Vergewissern Sie sich immer, dass die von Ihnen gewählte Befestigungsmethode für Ihr Zuhause geeignet und sicher ist. Angesichts der Vielfalt an Wand- und Deckenmaterialien sind Dübel und Schrauben zur Befestigung an Wand und Decke nicht enthalten. Wenden Sie sich an Ihren örtlichen Baumarkt, um sich über geeignete Dübel und Schrauben zu informieren.

**NO:** VIKTIG! Monteringsskruer er ikke inkludert. Forsikre deg alltid om at festemetoden du velger er egnet og sikker for hjemmet ditt. Fordi vegg- og tetningsmaterialer varierer, er ikke rawplugg og skruer for festing til vegg og tetning inkludert. Kontakt den lokale jernvarehandelen for råd om egnede veggplugg og skruer.

**SE:** VIKTIGT! Fästskruvar ingår ej. Se alltid till att vald fästättningsmetod passar och är säker för ditt hem. Eftersom materialet i väggar och tak varierar ingår inte råplugg och skruvar för montering i vägg och tak. Besök din lokala bygghandel eller järnaffär och rådfråga där vilken typ av väggpluggar och skruvar du behöver.

**NL:** BELANGRIJK!! Montageschroeven zijn niet inbegrepen. Zorg er altijd voor dat de bevestigingsmethode die u kiest geschikt en veilig is voor uw huis. Aangezien wand- en plafondmateriaal varieert, zijn de pluggen en schroeven voor bevestiging aan de wand en het plafond niet inbegrepen. Neem contact op met uw plaatselijke bouwmarkt voor advies over geschikte pluggen en schroeven.

**FR:** IMPORTANT ! Les vis de montage ne sont pas incluses. Assurez-vous toujours que la méthode de fixation que vous choisissez est adaptée et sûre pour votre maison. Étant donné que les matériaux pour les murs et plafonds varient, les chevilles et vis pour la fixation au mur et au plafond ne sont pas incluses. Contactez votre quincaillerie locale pour obtenir des conseils sur les chevilles et les vis adaptées.

**ES:** ¡IMPORTANTE! No se incluyen tornillos de montaje. Asegúrate siempre de que el método de fijación que elijas sea adecuado y seguro para tu hogar. Como los materiales de la pared y el techo pueden variar, no se incluyen los tacos ni los tornillos para la fijación a la pared y al techo. Acude a la ferretería más cercana para que te asesoren sobre los tacos y tornillos adecuados.

## Use of the product

---



**EN:** This product is only for indoor use.

**DK:** Dette produkt er kun til indendørs brug.

**DE:** Dieses Produkt darf nur in Innenräumen verwendet werden.

**NO:** Dette produktet er kun ment for innendørs bruk.

**SE:** Den här produkten är endast avsedd för inomhusbruk.

**NL:** Dit product is uitsluitend bedoeld voor gebruik binnenshuis.

**FR:** Ce produit est uniquement destiné à un usage intérieur.

**ES:** Aquest producte només es pot fer servir a l'interior.

Tools overview

---

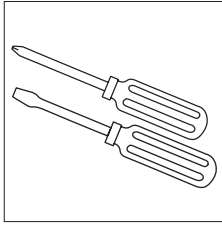
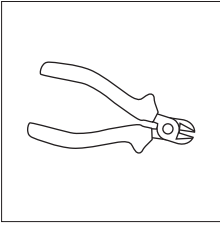

Not included

---

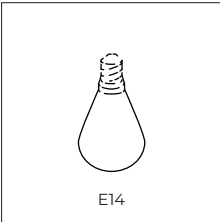

**STEP 01 - Lamp assembly**

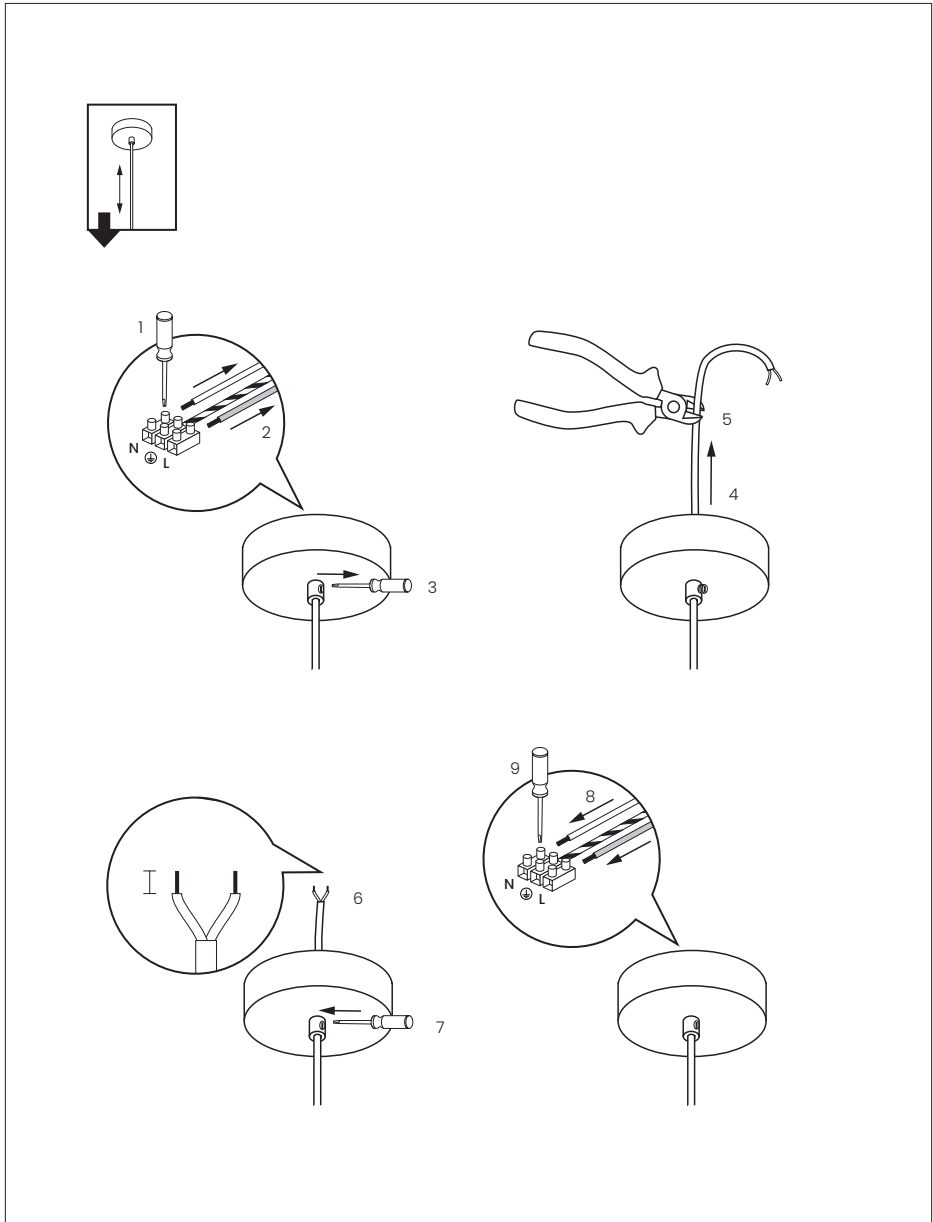

**STEP 02 - Lamp assembly**

