







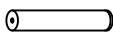

I			4
H			2
G		5mm	1
F			4
E			4
D		M8	32
C		M8*45	4
B		M8*50	8
A		M8*25	40
NO	PART DIAGRAM	PART SIZE	QTY

FIG.
1

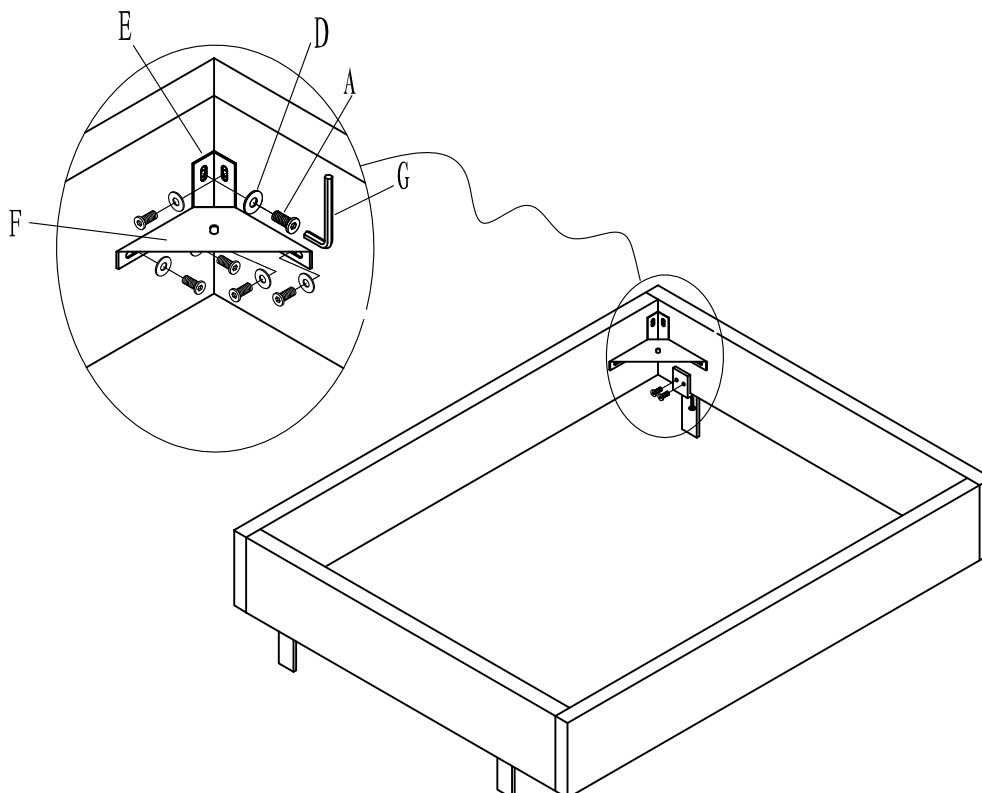

FIG.
2

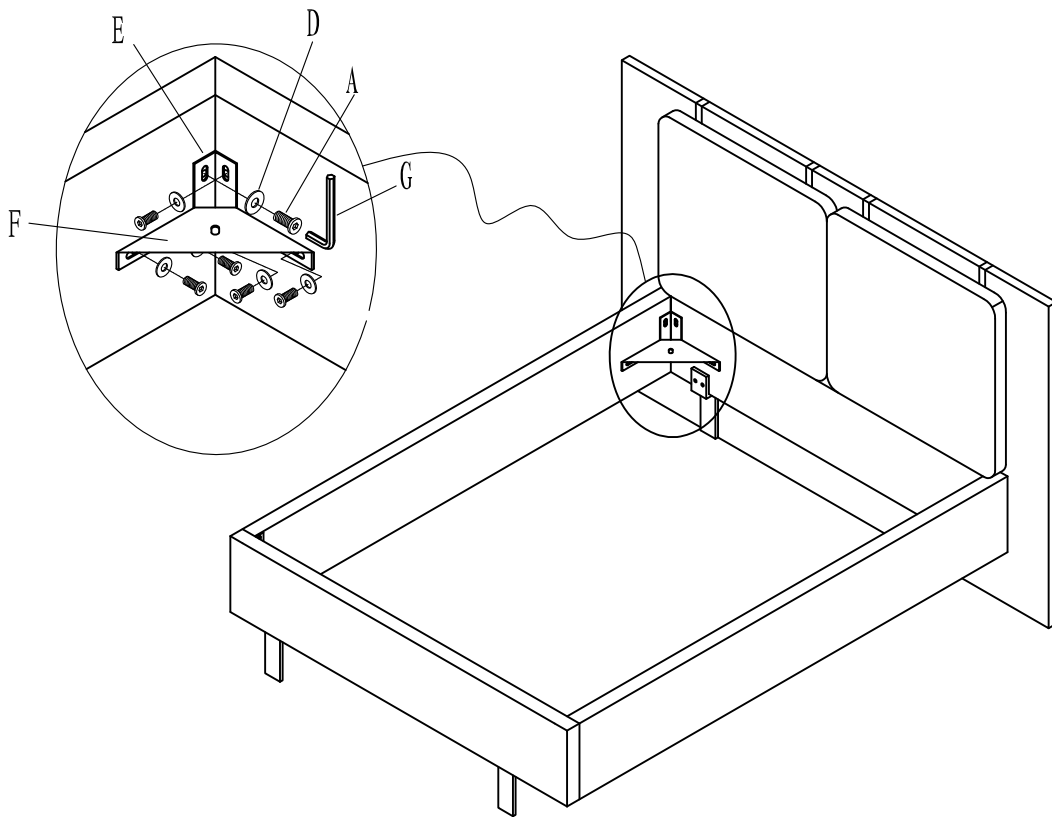

FIG.
3

