

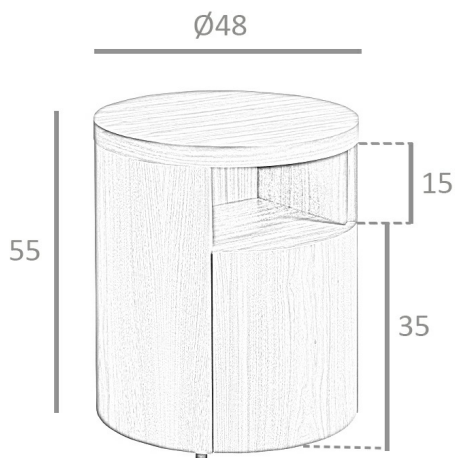



7006



 $\text{Ø}48 \times 55 \text{ cm.}$

 $0,19 \text{ m}^3$

 $23,00 \text{ Kg.}$

 $56 \times 56 \times 60 \text{ cm.} / 25 \text{ Kg.}$