





A	B	C	D	E
 M8x35	 M8x30	 $\phi 17x \phi 8x2$	 5mm	 6mm
12 PCS	8 PCS	20 PCS	1 PC	1 PC





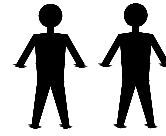
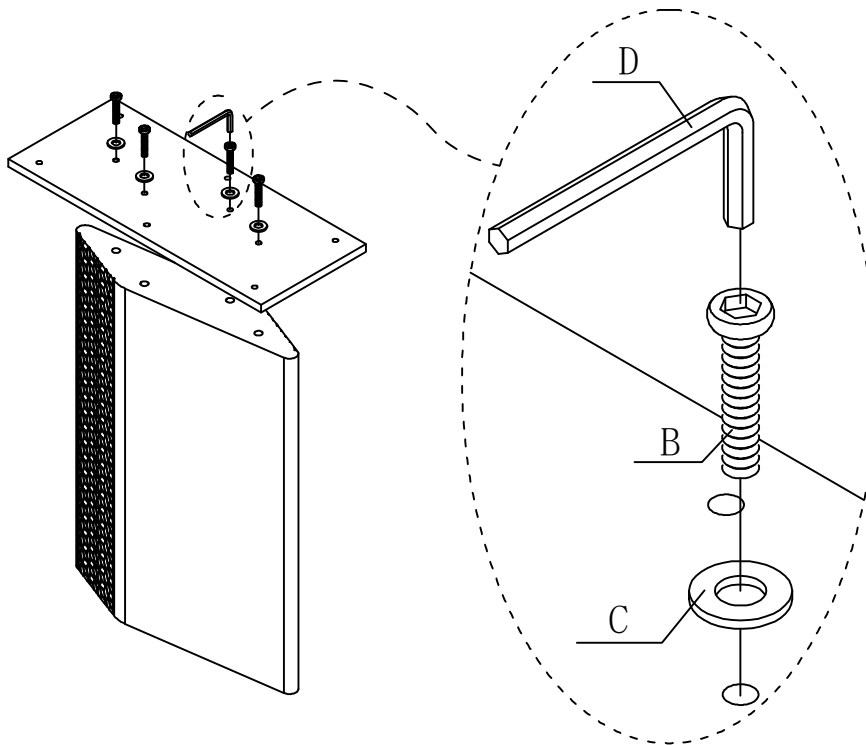

**FIG.**  
**1**

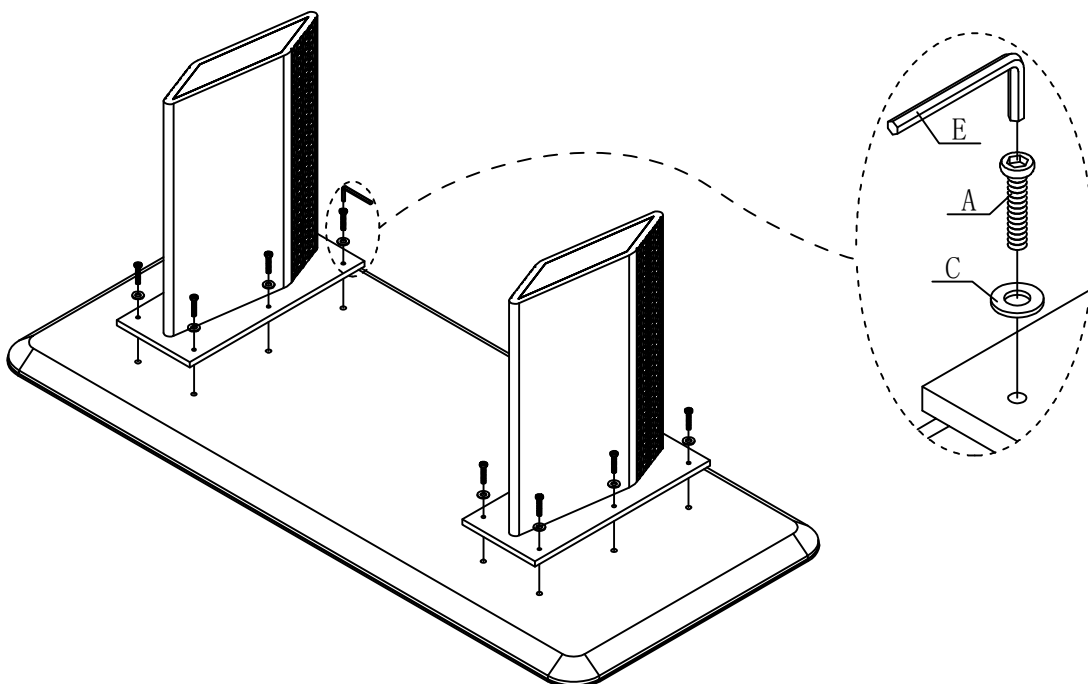

**FIG.**  
**2**



A	B	C	D	E
 M8x35	 M8x30	 φ 17x φ 8x2	 5mm	 6mm
12 PCS	8 PCS	20 PCS	1 PC	1 PC

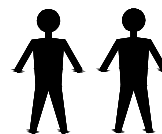

**FIG.**  
**3**

